

Installation and Configuration Manual

ENERGYMANAGER

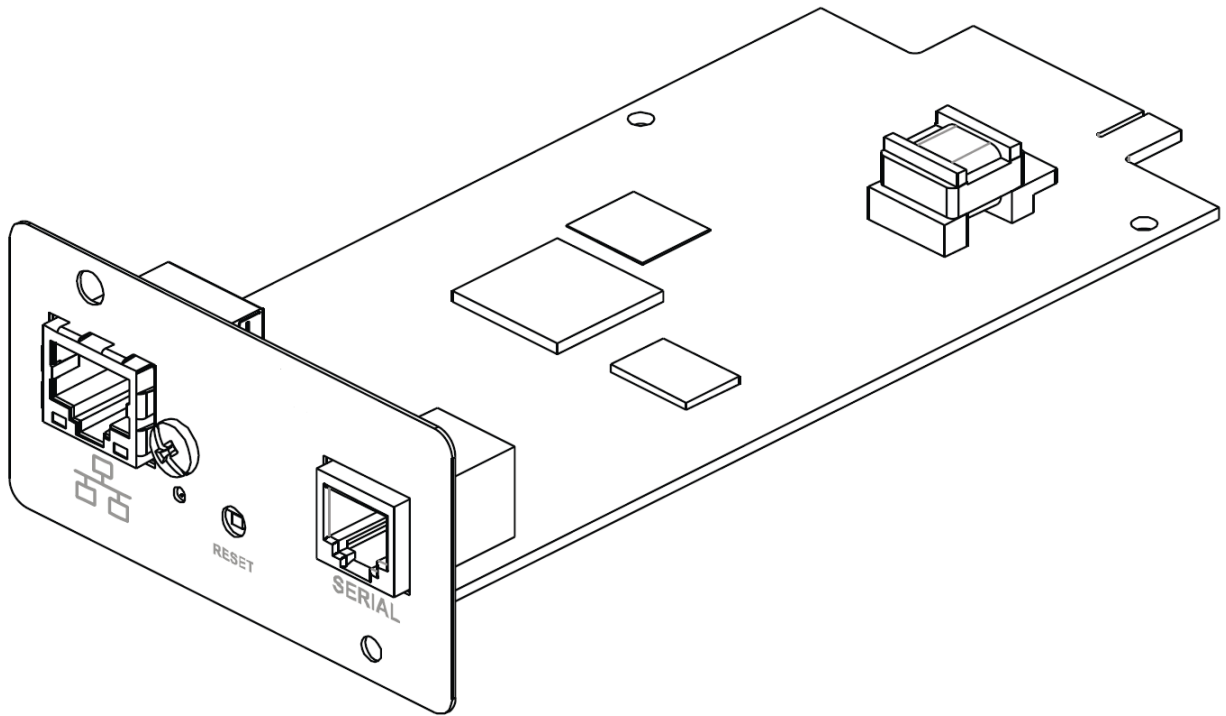

RPS SpA – Riello Power Solutions

Viale Europa, 7
37045 Legnago (VR)
Italy

www.riello-ups.com

EnergyManager Firmware Version

- This manual refers to the EnergyManager firmware version **02.00.03**; there may be some differences with later versions of the software.

INTRODUCTION

Thank you for choosing our product "EnergyManager".

The EnergyManager packaging includes:

- EnergyManager board
- Installation and Configuration Manual
- Standard cable to connect the EnergyManager board to the GS-Yuasa BMS (**Cable A**)
- Adapter cable to connect the EnergyManager board to the Vision GBMS (**Cable B**)
- USB key containing Installation and Configuration Manual and EnergyManager Configurator software.

Below the specification of the supplied **Cable A** used for connecting the EnergyManager board to the GS-Yuasa BMS.

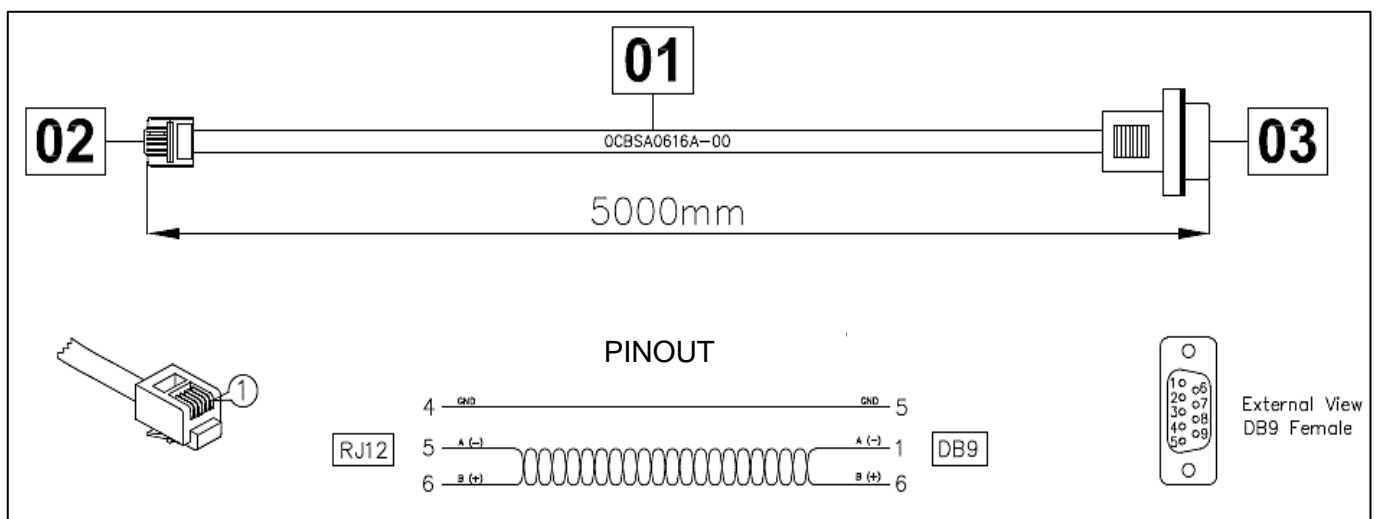

Below the specification of the supplied adapter **Cable B** used with cable A for connecting the EnergyManager board to the Vision GBMS.

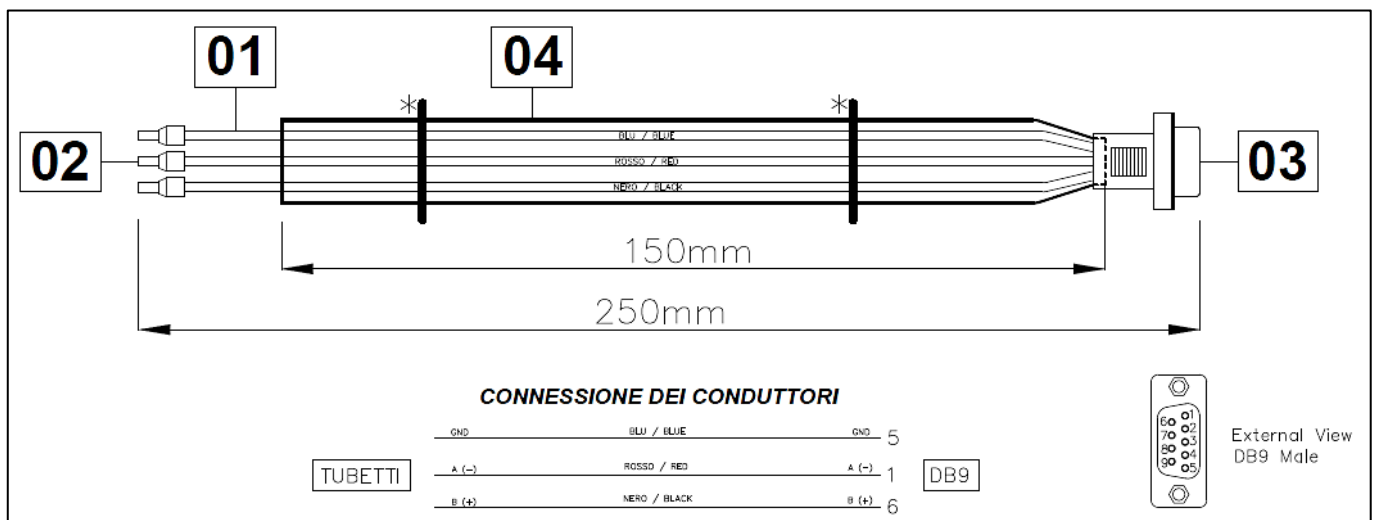

A (-) = wire Red B (+) = wire Black GND = wire Blue

The accessories described in this manual are high quality products, rigorously designed and built for optimal performance.

This manual contains detailed instructions on how to use and install the product. You should read this manual carefully before installing and using the tools.

This manual must be stored in a safe place and CONSULTED BEFORE USING THE DEVICE in order to grand proper usage as well as maximum performance from the device itself.

If you encounter any problems, please check with this manual again before contacting the local dealer or distributor.

Please keep this helpful Installation and Configuration Manual with you for your pleasant application of this product.

COMPATIBILITY TABLE:

The EnergyManager product is compatible with the following UPS series:

Features	UPS Product Series			
	NextEnergy NXE	Master HP MHT	Master HE MHE	Master MPS MPT
<i>BMS GS-Yuasa Li-ion battery</i>	✓	✓	✓	✓
<i>BMS Cegasa Li-ion battery</i>	✓	✓	✓	✓
<i>BMS Vision Li-ion battery</i>	✓	✓	✓	✓
<i>Peak shaving function</i>	✓	✓	✓	✓
<i>MODBUS/TCP server function</i>	✓**	✓	✓	✓**
<i>Master/Slave function</i>	✓	✓	✓	✓
<i>SLOT to use for EnergyManager</i>	SLOT 2	SLOT 2	SLOT 2	SLOT 2

Features	UPS Product Series		
	Sentryum Multi-Power	Multi Power MPW MPX	Multi Power2 MP2 M2S
<i>BMS GS-Yuasa Li-ion battery</i>	✓	✓	✓
<i>BMS Cegasa Li-ion battery</i>			
<i>BMS Vision Li-ion battery</i>	✓	✓	✓
<i>Peak shaving function</i>			✓
<i>MODBUS/TCP server function</i>			
<i>Master/Slave function</i>	✓	✓	✓
<i>SLOT to use for EnergyManager</i>	SLOT 1	SLOT 1	SLOT 1



Features	Storage Product Series	
	HBS	HBS HE
<i>BMS GS-Yuasa Li-Ion battery</i>	✓	✓
<i>BMS Cegasa Li-Ion battery</i>	✓	✓
<i>BMS Vision Li-ion battery</i>	✓	✓
<i>Peak shaving function</i>	✓	✓
<i>MODBUS/TCP server function</i>	✓**	✓
<i>Master/Slave function</i>	✓	✓
<i>SLOT to use for EnergyManager</i>	SLOT 2	SLOT 2

** Not all commands are available, refer to the chapter "MODBUS / TCP SERVER FUNCTION"

SYMBOLS USED IN THE MANUAL

ICONS

In this manual, some operations are shown by graphic symbols to alert the reader to the dangerous nature of the operations:

	DANGER	This symbol indicates the possibility of serious injury to the person and/or substantial damage to the unit if the indicated instructions are not followed
	WARNING	This symbol warns you about a procedure that if not correctly executed can lead to damage to the equipment
	READING	This symbol indicates information and/or procedures that are recommended to be read carefully

SAFETY

This part of the manual contains SAFETY precautions that must be followed scrupulously.

- ❖ The device has been designed for professional use and is therefore not suitable for use in the home.
- ❖ The device has been designed to operate only in closed environments. It should be installed in rooms where there are no inflammable liquids, gas or other harmful substances.
- ❖ Take care that no water or liquids and/or foreign bodies fall into the device.
- ❖ In the event of a fault and/or impaired operation of the device, do not attempt to repair it but contact the authorized service centre.
- ❖ The device must be used exclusively for the purpose for which it was designed. Any other use is to be considered improper and as such dangerous. The manufacturer declines all responsibility for damage caused by improper, wrong and unreasonable use.

ENVIRONMENTAL PROTECTION

Our company devotes abundant resources to analyzing environmental aspects in the development of its products. All our products pursue the objectives defined in the environmental management system developed by the company in compliance with applicable standards.

Hazardous materials such as CFCs, HCFCs or asbestos have not been used in this product.

When evaluating packaging, the choice of material has been made favoring recyclable materials. Please separate the different material of which the packaging is made and dispose of all material in compliance with applicable standards in the country in which the product is used.

DISPOSING OF THE PRODUCT

The device contains internal material which (in case of dismantling/disposal) are considered TOXIC, such as electronic circuit boards. Treat these materials according to the laws in force, contacting qualified centers. Proper disposal contributes to respect for the environment and human health.

<i>DESCRIPTION</i>	<i>MATERIAL</i>
Package box	Corrugated cardboard
Protective bag	Polyethylene
Bubble wrap	Polyethylene

INDEX

EnergyManager BOARD INFORMATION	1
EnergyManager BOARD INSTALLATION.....	3
Communication Diagram with Serial BMS (Yuasa - Vision)	4
Communication Diagram with Ethernet BMS (Cegasa)	4
EnergyManager BOARD CONFIGURATION	5
Software Installation for Windows.....	5
Board Configuration	6
Configuration and components	11
BMS FUNCTION.....	12
BMS GS-Yuasa	12
BMS Cegasa.....	13
BMS Vision	14
PEAK SHAVING FUNCTION	15
Power and Communication Diagram.....	16
Power Meter Connection	17
Ethernet Interface Configuration - LOVATO	18
Ethernet Interface Configuration - JANITZA.....	19
Peak shaving configuration	20
Power Meter Configuration	20
MODBUS/TCP SERVER FUNCTION.....	21
MASTER/SLAVE FUNCTION.....	24
Configuration example for a common battery system:	25
Communication Diagram with Serial BMS and Power Meter	26
Communication Diagram with Ethernet BMS and Power Meter	26
EnergyManager MONITORING	27
FIRMWARE UPGRADE	28
UPS SETTING.....	32
Configuration for NextEnergy and Master series	32
Configuration for UPS Sentryum (S3T/S3M/S3U)	32
Configuration for UPS Multi Power (MPW/MPX)	33
Configuration for UPS Multi Power2 (MP2/M2S).....	34
ALARM MESSAGES	35

ENERGYMANAGER BOARD INFORMATION

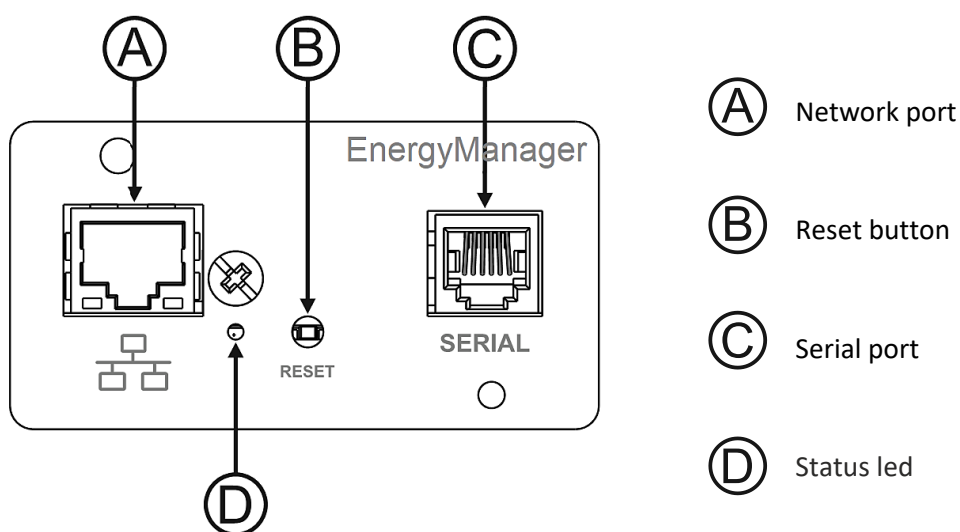

Network port

EnergyManager connects to 10/100/1000 Mbps Ethernet networks by means of connector RJ45. The LEDs built into the connector describe the status of the network:

Left LED (green)	Right LED (yellow)	Link / Activity
OFF	OFF	Link Off
ON	OFF	1000 Link / No Activity
Blinking	OFF	1000 Link / Activity (RX, TX)
OFF	ON	100 Link / No Activity
OFF	Blinking	100 Link / Activity (RX, TX)
ON	ON	10 Link / No Activity
Blinking	Blinking	10 Link / Activity (RX, TX)

Reset button

The reset button enables the user to execute a *system reboot* or enter the *recovery mode*.

- **System reboot:** keep the reset button pressed until the status led starts blinking and then release it.
- **Recovery mode:** keep the reset button pressed; first the status led starts blinking, then turns to solid green (approx. 5 seconds). When the led is solid green, release the reset button.

Serial port

EnergyManager makes available a RS485 serial communication port.

Status led

This led describes the status of *EnergyManager*:

Led color	Description
BLINKING GREEN / YELLOW	Normal operation
SOLID YELLOW	Not Configured
SOLID RED	General error
FAST BLINKING GREEN	Reset button pressed or Recovery mode running

ENERGYMANAGER BOARD INSTALLATION

1. Remove the cover SLOT 1 or 2 (refer to the Compatibility Table) from the UPS by removing the two retaining screws
2. Carefully insert EnergyManager board into the SLOT
3. Secure the board in the SLOT using the two previously removed screws
4. Connect the board to the network by insert plug of the Ethernet cable into the RJ-45 connectors (required for Board configuration and Ethernet devices)
5. If required, connect SERIAL PORT (RJ-12) to the external devices (BMS or others), using **Cable A** and/or **Cable B** according to the device connector pinout.
6. The EnergyManager board and cables are now safely installed on the UPS

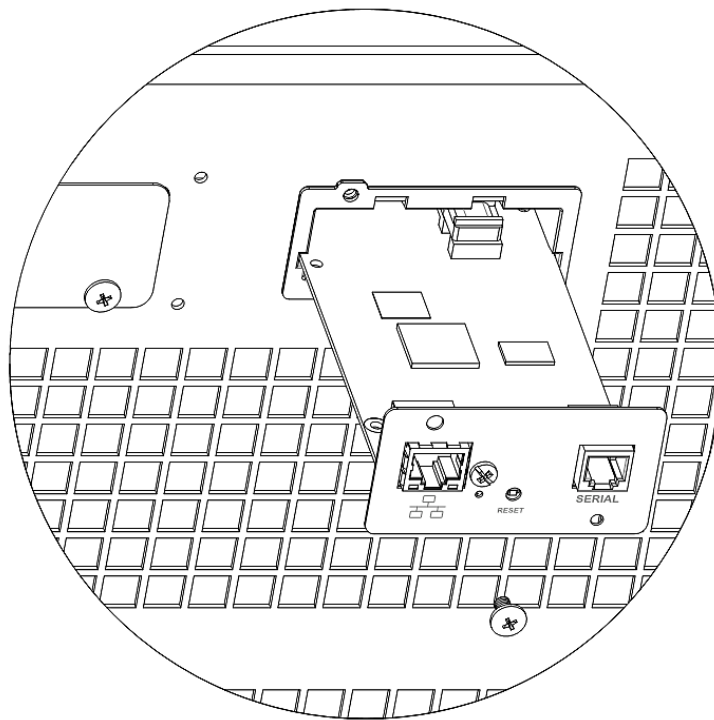

EnergyManager requires approximately 2 minutes to become fully operational from when it is powered up or following a reboot; before this time the device may not respond to commands that are sent to it.

Based on the type of application follow one of the below communication diagrams.

COMMUNICATION DIAGRAM WITH SERIAL BMS (YUASA - VISION)

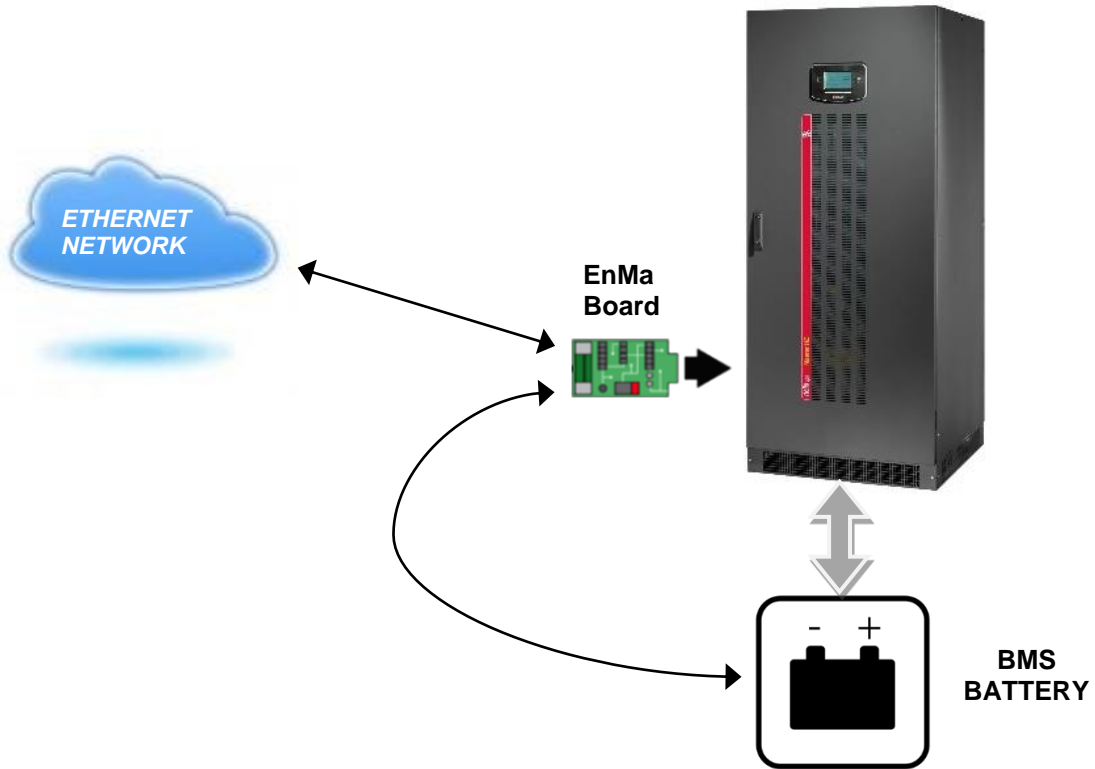

COMMUNICATION DIAGRAM WITH ETHERNET BMS (CEGASA)

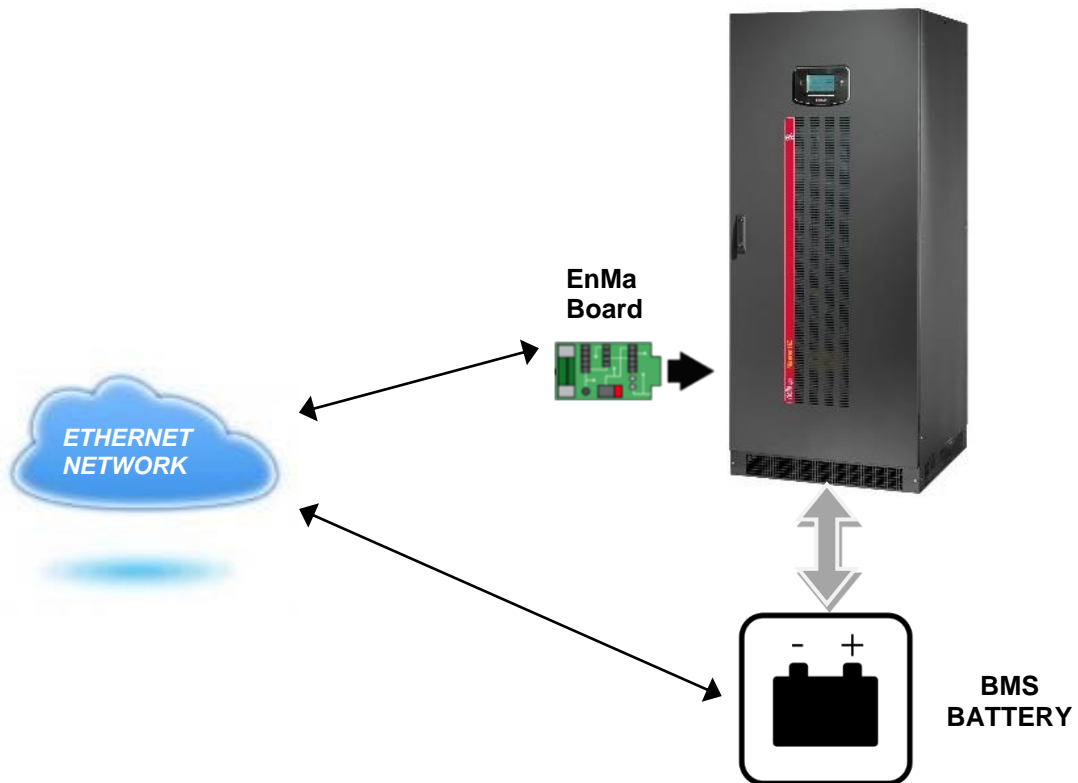

ENERGYMANAGER BOARD CONFIGURATION

The EnergyManager Configuration Software has the purpose to configure the EnergyManager board and in case, to update its firmware.

The board has 2 interfaces, an RS485 serial port and an Ethernet interface.

The PC running the EnergyManager Configuration Software has to be connected to the board using the same LAN interface.

The EnergyManager Configuration Software is available for Windows.

The EnergyManager board has a default configuration, with no devices configured and a simple IP static address:

IP: 192.168.1.200

Netmask: 255.255.0.0

Notice that the user doesn't have to care about the default IP address, the EnergyManager Configuration Software can configure the board even if the IP address of the PC has a different network definition, so there is no need to change the IP address of the PC.

The maximum number of devices configurable on the board is 10, and they can act on both RS485 and Ethernet connections.

The EnergyManager Configurator Software can be found on the USB key supplied with the board.

SOFTWARE INSTALLATION FOR WINDOWS

For Windows OS the installation package is:



Double click on the EnergyManager installation package and follow the instructions, as usual. After installation, on the PC Desktop will be available a new alias like this:



BOARD CONFIGURATION

Once the application has started, the operator should see a window like this:

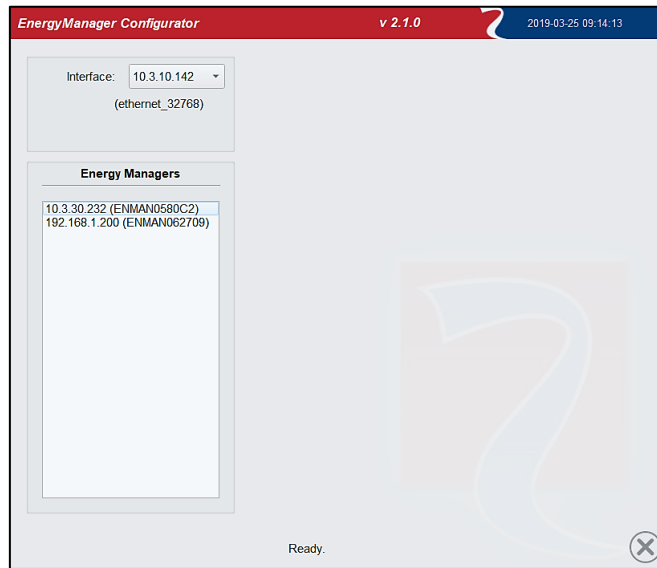

The screen is divided in two parts. The left side contains all the visible UPS or boards compatible with EnergyManager Configuration Software, they will appear in the corresponding list. A list of interfaces allows to choose the preferential interface to be used with the device. The right part will be filled when the user selects (clicks) one of the boards/UPS on the left.

By clicking on a device it will show on the right side of the window the configuration of the selected device:

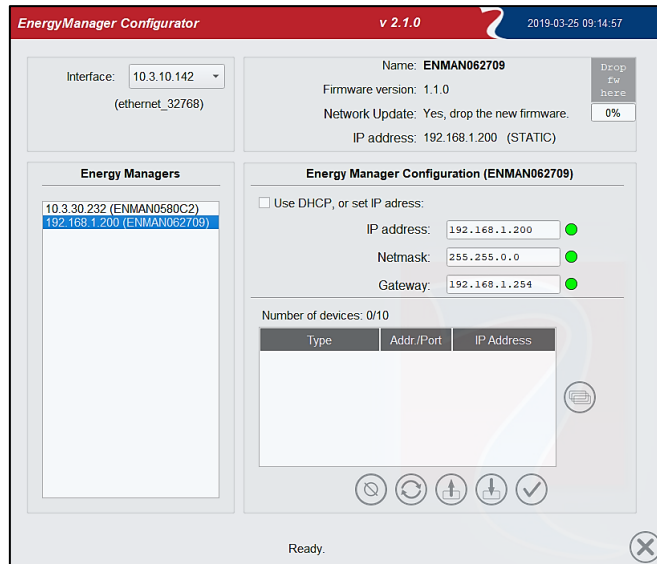

The operator will see:

- The name of the EnergyManager board
- The version of the software running on the board
- If the board is updatable from the software (via drag and drop)
- The current IP address and, if statically allocated, the caption "STATIC"
- An empty list of configured devices

Selecting an EnergyManager board already configured, we have, for instance:

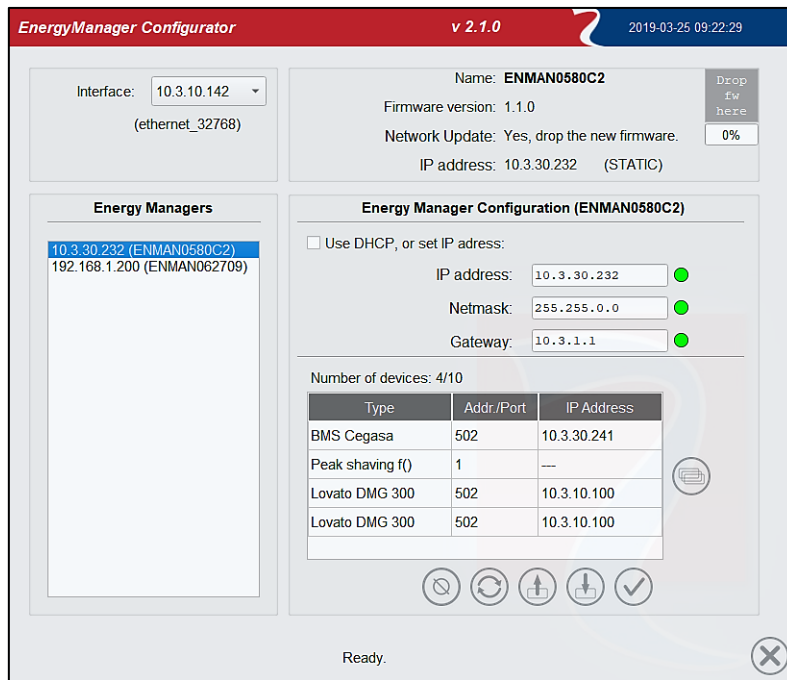

On the right, there is the configuration for the network parameters:

- DHCP option (dynamically assigned IP address)
- If not DHCP is selected, it's possible to configure the IP address, Netmask and, if necessary, the gateway.

Going down from there, we have the part that allows the operator to modify the board configuration.

If the operator clicks on the button  the following screen appears:

the EnergyManager configurator will show a window for selecting the devices to add/modify the current configuration:

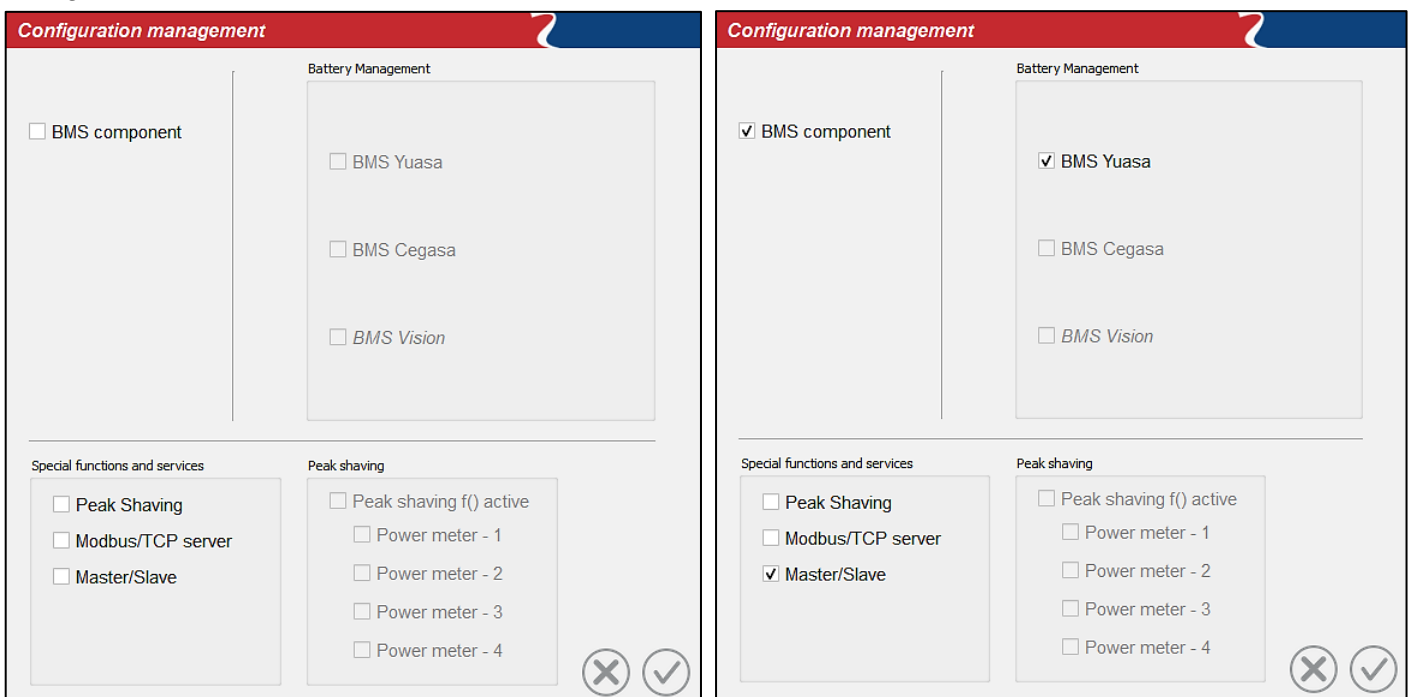

When operating with the configurations, notice that not all the combinations are available. The RWE configuration, for example, if selected, doesn't allow to add any other object. Notice also that in the future the software will support more devices, so the image here is only for reference.

The devices compatible with EnergyManager board are:

- BMS - Yuasa
- BMS - Cegasa
- BMS - Vision
- Peak shaving f()
 - Lovato DMG300 + EXM10 13 - Power Meter with Ethernet Interface [note 1]
 - Janitza UMG 96RM-E - Power Meter with Ethernet Interface [note 1]

This document will show more details for modifying a board configuration later.

Let's focus now on the configuration of the single board:

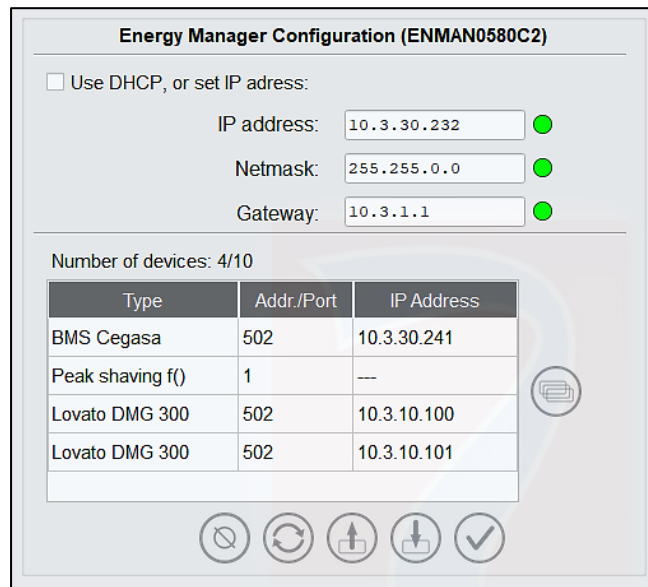

In this part of the window we can modify the IP address/netmask and gateway or to choose for a DHCP assigned IP address.

Below we can see the objects configured into the board. In the above example, there is a Peak Shaving function using, two Power Meter Lovato DMG 300 with a BMS Cegasa.

Right-clicking on a single device it's possible to Edit or Delete the device itself:

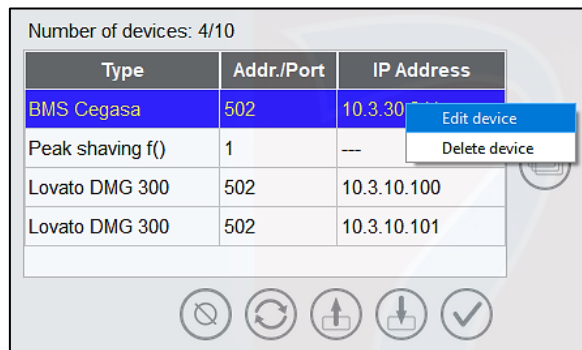

Notice:

- Editing can also be done just double-clicking on a device
- Not all devices can be deleted

[note 1 - models may change over time, make sure they have an ethernet interface for communication.]

If we decide to edit the BMS device, a window will appear, where we can modify some parameters.

The screenshot shows a 'Modify a device' window with a red header. The title bar contains 'Modify a device' on the left and 'Name: EN 2019-03-25 09:55:36' on the right. The main content area is divided into three sections:

- Device Type:** Peak shaving f()
- Configuration:** Port: 1, IP Address: N.A.
- Parameter Info:** P1: Max Power of Plant: [10;65000] KW

On the right side, there is a 'Parameters' section with a grid of 32 input fields (P1 to P32). P1 is set to 10, P3 to 500, and P4 to 2. All other parameters (P2, P5-P32) are set to 0. At the bottom right, there are two circular buttons: a red 'X' for cancel and a green checkmark for confirm.

If we decide to edit the Power Meter, a window will appear. On the left side, we can modify the Device Brand, the Port and the IP address.

The screenshot shows a 'Modify a device' window with a red header. The title bar contains 'Modify a device' on the left and '2020-04-27 12:15:50' on the right. The main content area is divided into three sections:

- Device Type:** Power Meter
- Configuration:** Port: 502, IP Address: 192.168.1.199, Device brand: Lovato
- Parameter Info:** (Empty box)

On the right side, there is a 'Parameters' section with a grid of 32 input fields (P1 to P32). P1 is set to 8, P2 to 44, and P3 to 1. All other parameters (P4-P32) are set to 0. At the bottom right, there are two circular buttons: a red 'X' for cancel and a green checkmark for confirm.

Notice that in the left side we see a Parameter Info panel that will contain the meaning of the current parameter under editing. For example:

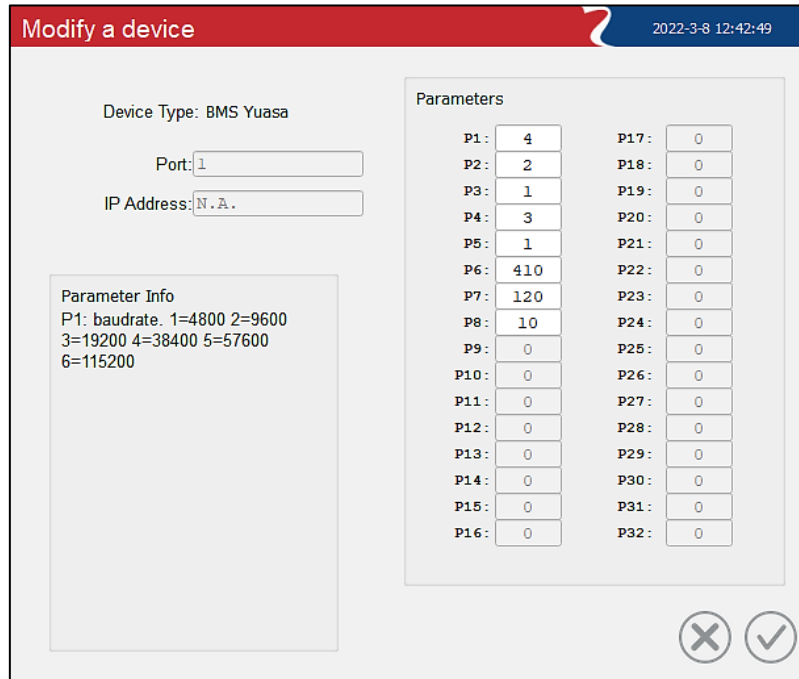

In the above picture the user has selected parameter 1, and on the left “Parameter Info” panel will appear the parameter value meaning. If the user changes a parameter with a wrong number, two things will happen:

- A red error message “Value not allowed...” will appear and a warning orange message “Invalid configuration” will appear
- It’s not possible to confirm the configuration with the apply button

In this case the apply button will be disabled.

When all the desired modifications are done, it’s possible to send the configuration directly to the board with the button highlighted in the image:

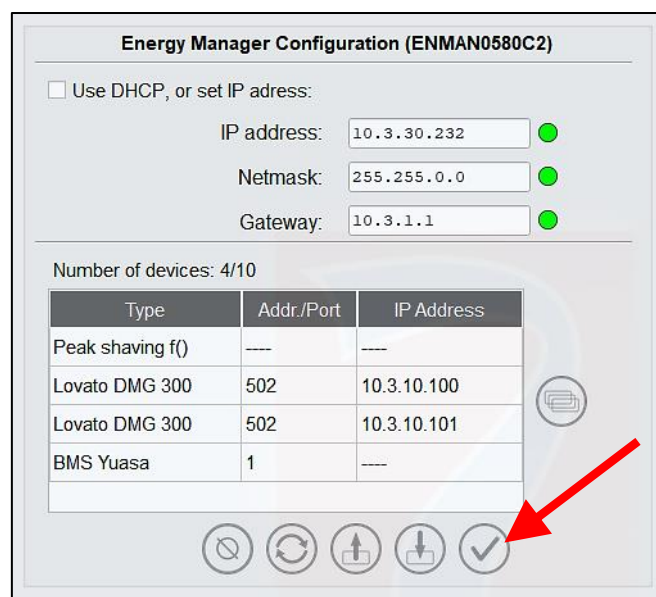

Hereafter a description of the other buttons highlighted in the figure



Description:

- 1- Delete all configured devices (with user confirmation)
- 2- Reload configuration from UPS/EnergyManager board
- 3- Load configuration from File
- 4- Save configuration to File

CONFIGURATION AND COMPONENTS

The components configuration window allows the user to add both single components and/or single configurations.

There are anyhow limitations that are reported in the usage of this window: **not all the combinations are possible, and the user is driven to a working set (defined configuration set) as below described:**

In detail we can have:

- Free single BMS configuration
- Peak shaving configuration (Peak shaving component with up to 4 x Power Meters) and, optionally, a BMS chosen from those currently approved by Riello-UPS
- Modbus/TCP server

As stated before, the software will disable all the wrong or not possible configurations.

BMS FUNCTION

Application: this function is used in case the Riello UPS products have to work with Batteries Monitoring System (BMS).

Lithium batteries are always coupled to a BMS for the battery supervision and for the safety of the installation.

For security and operative reason, the BMS must communicate with the UPS via a data interface.

The BMS devices approved and compatible with EnergyManager board are:

- BMS - GS-Yuasa
- BMS - Cegasa
- BMS - Vision

BMS GS-YUASA

The GS-Yuasa lithium battery models compatible with the EnergyManager board are:

Battery: LIM25H - LIM50EN - LIM50EL

BMS: LIBMII

Connection Type : Serial RS485 (Cable A)

The parameters that can be changed are those related to the serial RS485 connection and the Battery:

Modify a device 2022-3-8 14:17:46

Device Type: BMS Yuasa

Port:

IP Address:

Parameter Info

P1: baudrate, 1=4800 2=9600
3=19200 4=38400 5=57600
6=115200

Parameters			
P1:	<input type="text" value="4"/>	P17:	<input type="text" value="0"/>
P2:	<input type="text" value="2"/>	P18:	<input type="text" value="0"/>
P3:	<input type="text" value="1"/>	P19:	<input type="text" value="0"/>
P4:	<input type="text" value="3"/>	P20:	<input type="text" value="0"/>
P5:	<input type="text" value="50"/>	P21:	<input type="text" value="0"/>
P6:	<input type="text" value="410"/>	P22:	<input type="text" value="0"/>
P7:	<input type="text" value="120"/>	P23:	<input type="text" value="0"/>
P8:	<input type="text" value="10"/>	P24:	<input type="text" value="0"/>
P9:	<input type="text" value="0"/>	P25:	<input type="text" value="0"/>
P10:	<input type="text" value="0"/>	P26:	<input type="text" value="0"/>
P11:	<input type="text" value="0"/>	P27:	<input type="text" value="0"/>
P12:	<input type="text" value="0"/>	P28:	<input type="text" value="0"/>
P13:	<input type="text" value="0"/>	P29:	<input type="text" value="0"/>
P14:	<input type="text" value="0"/>	P30:	<input type="text" value="0"/>
P15:	<input type="text" value="0"/>	P31:	<input type="text" value="0"/>
P16:	<input type="text" value="0"/>	P32:	<input type="text" value="0"/>

In detail, the user can change:

- P1 = Baud rate
- P2 = Number of data bits (1=7 or 2=8)
- P3 = Number of stop bits (1 or 2)
- P4 = Parity
- P5 = Total Battery Capacity, Ah (min 1 - max 10000Ah)
- P6 = Cell charge voltage in 0.01V units (from 360 to 420V – 3.6 to 4.2V)
- P7 = Number of Cell in series (from 96 to 180)
- P8 = Cell charge current expressed in terms of capacity (from 0.01C to 10.00C) [default value 10=0.1C]

BMS CEGASA

The CEGASA lithium battery models compatible with the EnergyManager board are:

Battery: eBick

BMS: MCP

Connection Type : Ethernet

The only parameters that can be changed are the port and IP Address of the CEGASA external device.

Modify a device 2020-04-27 11:54:17

Device Type: BMS Cegasa

Port:

IP Address: ●

Parameter Info

Parameters

P1:	<input type="text" value="0"/>	P17:	<input type="text" value="0"/>
P2:	<input type="text" value="0"/>	P18:	<input type="text" value="0"/>
P3:	<input type="text" value="0"/>	P19:	<input type="text" value="0"/>
P4:	<input type="text" value="0"/>	P20:	<input type="text" value="0"/>
P5:	<input type="text" value="0"/>	P21:	<input type="text" value="0"/>
P6:	<input type="text" value="0"/>	P22:	<input type="text" value="0"/>
P7:	<input type="text" value="0"/>	P23:	<input type="text" value="0"/>
P8:	<input type="text" value="0"/>	P24:	<input type="text" value="0"/>
P9:	<input type="text" value="0"/>	P25:	<input type="text" value="0"/>
P10:	<input type="text" value="0"/>	P26:	<input type="text" value="0"/>
P11:	<input type="text" value="0"/>	P27:	<input type="text" value="0"/>
P12:	<input type="text" value="0"/>	P28:	<input type="text" value="0"/>
P13:	<input type="text" value="0"/>	P29:	<input type="text" value="0"/>
P14:	<input type="text" value="0"/>	P30:	<input type="text" value="0"/>
P15:	<input type="text" value="0"/>	P31:	<input type="text" value="0"/>
P16:	<input type="text" value="0"/>	P32:	<input type="text" value="0"/>

BMS VISION

The Vision lithium battery models compatible with the EnergyManager board are:
Battery: LFP512VxxxAH
BMS: GBMS Vision

Connection Type : Serial RS485 (Cable A + B)

The parameters that can be changed are those related to the serial RS485 connection and the Battery:

Modify a device 2022-3-9 9:21:36

Device Type: BMS Vision

Port:

IP Address:

Parameter Info
P1: baudrate. 1=4800 2=9600
3=19200 4=38400 5=57600
6=115200

Parameters

P1:	<input type="text" value="2"/>	P17:	<input type="text" value="0"/>
P2:	<input type="text" value="2"/>	P18:	<input type="text" value="0"/>
P3:	<input type="text" value="1"/>	P19:	<input type="text" value="0"/>
P4:	<input type="text" value="1"/>	P20:	<input type="text" value="0"/>
P5:	<input type="text" value="400"/>	P21:	<input type="text" value="0"/>
P6:	<input type="text" value="550"/>	P22:	<input type="text" value="0"/>
P7:	<input type="text" value="50"/>	P23:	<input type="text" value="0"/>
P8:	<input type="text" value="0"/>	P24:	<input type="text" value="0"/>
P9:	<input type="text" value="0"/>	P25:	<input type="text" value="0"/>
P10:	<input type="text" value="0"/>	P26:	<input type="text" value="0"/>
P11:	<input type="text" value="0"/>	P27:	<input type="text" value="0"/>
P12:	<input type="text" value="0"/>	P28:	<input type="text" value="0"/>
P13:	<input type="text" value="0"/>	P29:	<input type="text" value="0"/>
P14:	<input type="text" value="0"/>	P30:	<input type="text" value="0"/>
P15:	<input type="text" value="0"/>	P31:	<input type="text" value="0"/>
P16:	<input type="text" value="0"/>	P32:	<input type="text" value="0"/>

In detail, the user can change:

- P1 = Baud rate
- P2 = Number of data bits (1=7 or 2=8)
- P3 = Number of stop bits (1 or 2)
- P4 = Parity
- P5 = Minimum Battery Voltage Discharge [default 400Vdc]
- P6 = Maximum Battery Voltage Charge [default 550 Vdc]
- P7 = Total Battery Capacity Ah (min 1 - max 10000Ah)

NOTE:

The proper Battery Voltage and Capacity value (P5-P6-P7) must be set accordingly with the value reported by the BMS VISION Battery Cabinet.

PEAK SHAVING FUNCTION

The purpose of the peak shaving system is to reduce peak demand of the power usage, shift usage to off-peak hours and lower total energy consumption.

In these applications, the power absorbed by the installation is constantly monitored, making it possible to automatically adapt the power consumption to the required levels.

The charge and discharge of the batteries is managed to reduce the power absorbed by the grid to a predetermined value.

Below an example of the daily power diagram:

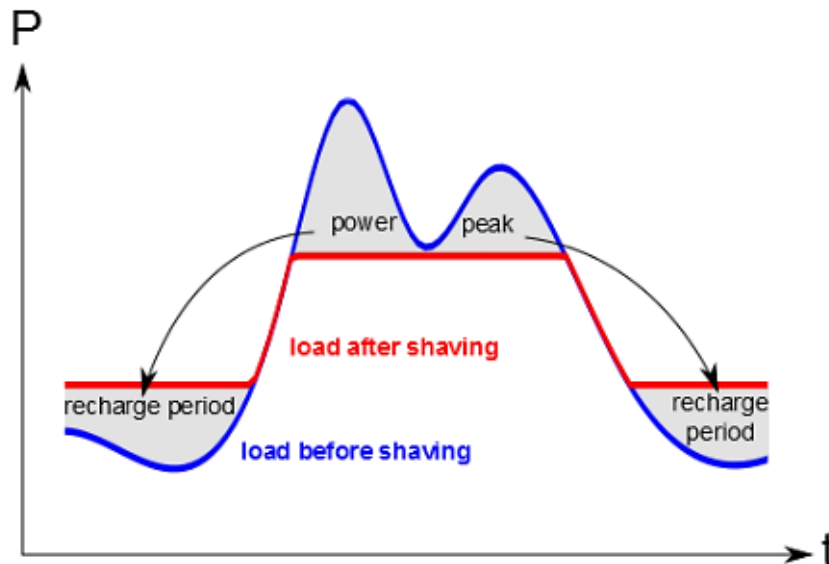

In the ups it is possible to set two percentage levels of the battery charge status (A.1 and A.2) that allow you to enable or disable the battery discharge.

Parameter A.2 indicates the battery charge percentage below which the battery discharge is disabled.

Parameter A.1 indicates the battery charge percentage above which the discharge is enabled again once threshold A.2 has intervened.

Parameters A.1 and A.2 can be set in the UPS via code 321776, by default they are set: A.1 = 0 and A.2 = 0

If the percentage of battery charge decreases below parameter A.2, or the "Battery pre-alarm" condition is activated, the battery discharge is disabled.

Therefore, the power absorbed by the grid could exceed the limit P1 set in the Peak-Shaving configuration, in this way the UPS will be able to absorb from the grid as much as is required by the privileged load and in this situation, battery charging is disabled.

When the load decreases and the power absorbed from the grid goes below the set limit (P1), the UPS can begin to recharge the batteries.

When the battery charge percentage rises above parameter A.1, battery discharge is enabled again.

The system is made of two components, an External Power Meter and the EnergyManager board.

External Power Meter:

It is necessary to install a Power Meter in order to measure the Power absorbed by the grid.

The Power Meter has to offer an Ethernet Interface using MODBUS/TCP protocol for communication with the EnergyManager board.

NOTE:

The Power Meter instruments approved and homologated by Riello-UPS are shown on page 8.

It is possible to install up to a maximum of n.4 External Power Meters to the same EnergyManager board, in this case the EnergyManager device will use as a parameter the sum of the powers of the installed Power Meters. If multiple Power Meters are required, they must all be of the same BRAND and MODEL.

EnergyManager Board:

The EnergyManager board must be installed in the SLOT- 2 of the UPS.

This board is connected to the Ethernet network to read the value of the connected power meter.

POWER AND COMMUNICATION DIAGRAM

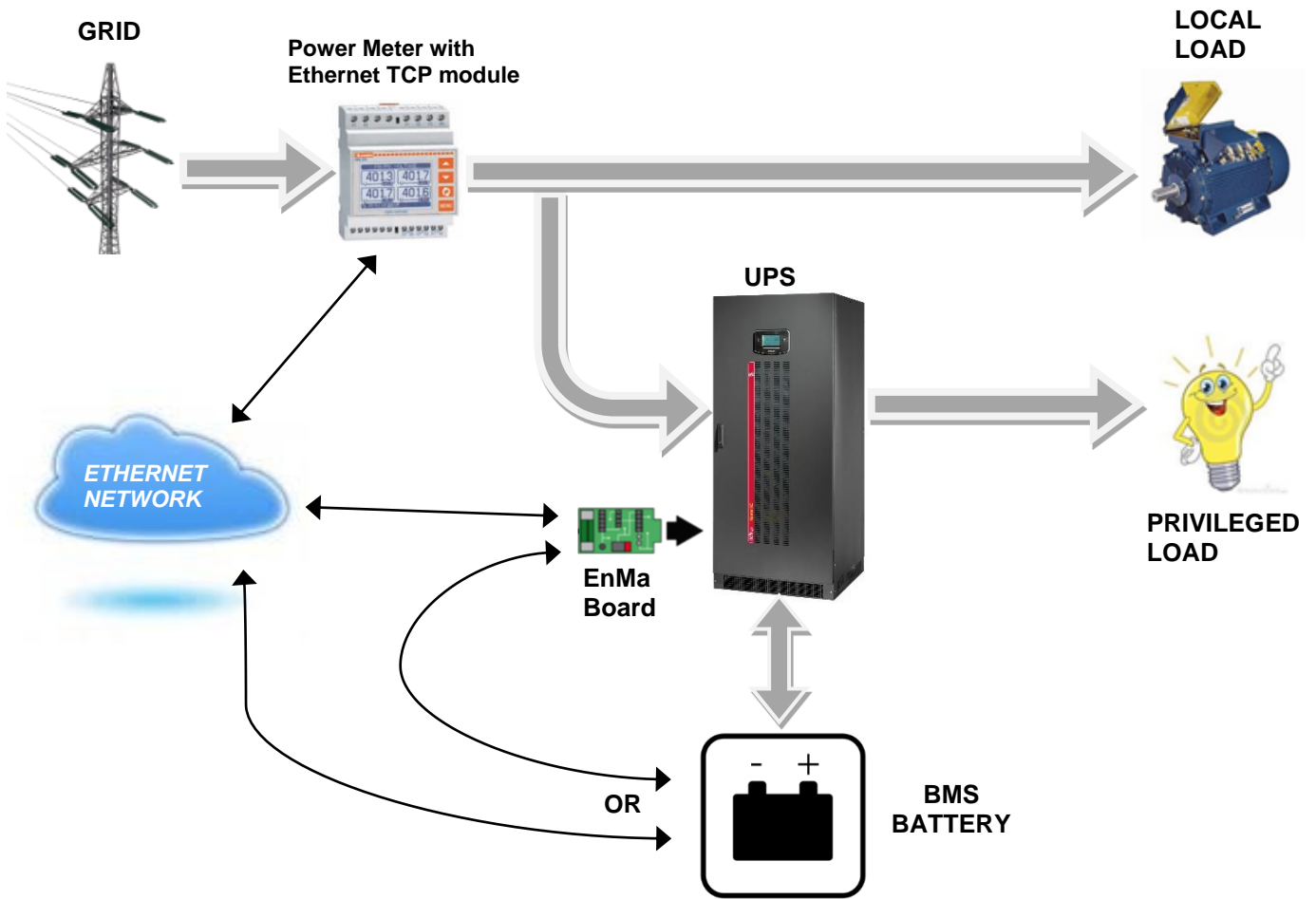

The instrument "Power Meter" must measure the power that flows from the grid. The EnergyManager board must be installed in a SLOT-2.

POWER METER CONNECTION



It's strongly forbidden to work on to devices in the presence of voltage

- Connect the Power Meter according to the diagram below
- Be very careful to connect the instrument correctly

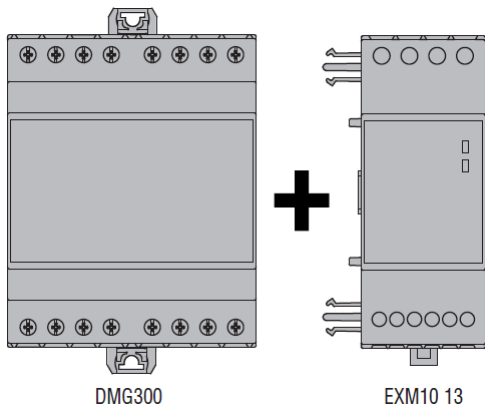
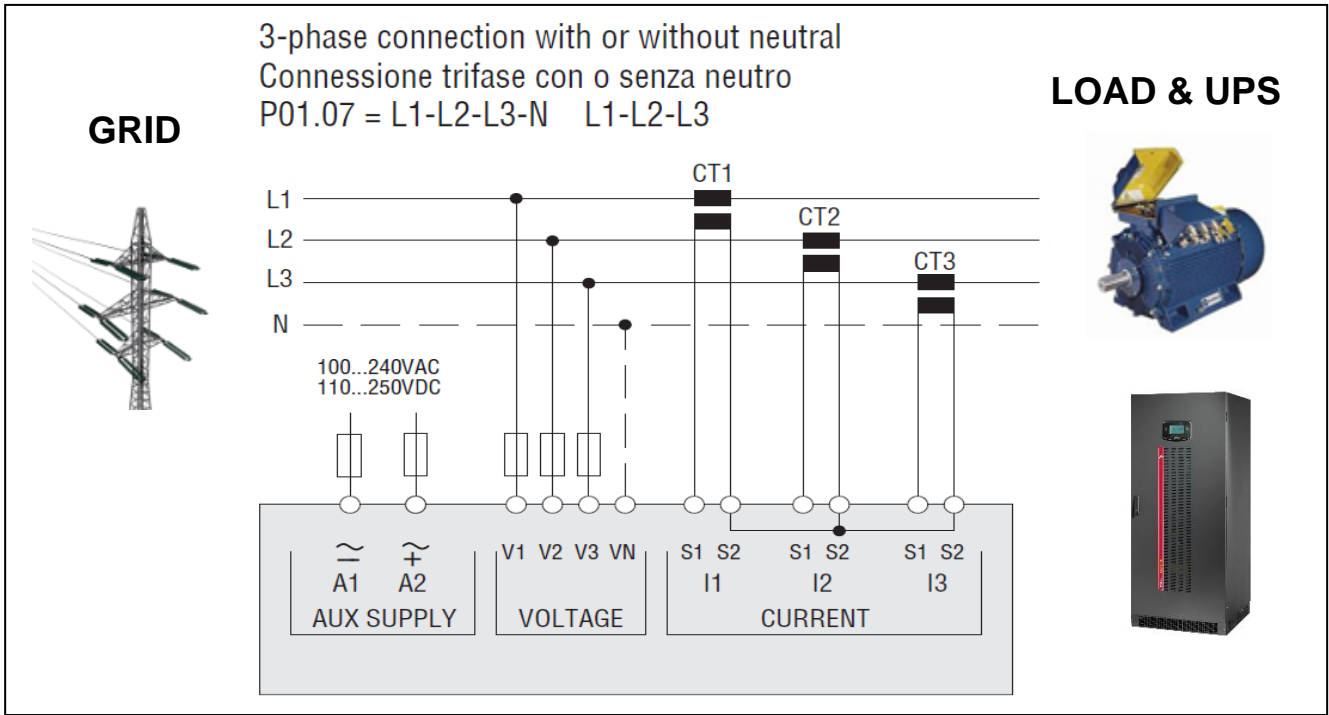



The instrument must be set and configured according with the range of the current transformers, for the instrument settings please refer to the instructions contained in the package of the instrument, "Parameter Setting" paragraph.

ETHERNET INTERFACE CONFIGURATION - LOVATO

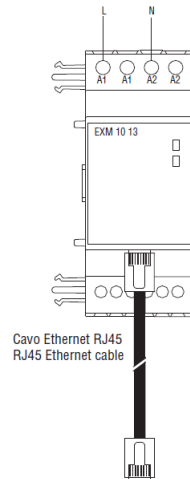

The Ethernet Interface Module must be set and configured according with the network to which it is connected, please refer to the instructions below.

- The main menu of the Power Meter is made up of a group of graphic icons (shortcuts) that allow rapid access to measurements and settings.
 - Starting from normal viewing, press MENU key. The main menu screen is displayed.
 - Press ▲▼ to select the required function. The selected icon is highlighted and the central part of the display shows the description of the function.
 - Press ↻ to activate the selected function.
- 1- From normal viewing, press MENU to recall the main menu, then select icon Set-up menu  and press ↻ to open the set-up menu screen.
 - 2- The display will show the table with the parameters grouped in sub-menus with a function-related criteria.
 - 3- Select the sub-menu “M07 COMMUNICATION” (Communication ports parameters) with ▲▼ keys and confirm with ↻
 - 4- This menu is divided into 2 sections, for comm channels COM1 and 2, select COM1 and set the parameters in the table below

M07 - COMMUNICATION		Default	SET
P07.1.05	Protocol	Modbus RTU	Modbus TCP
P07.1.06	IP address	000.000.000.000	Set the correct IP address
P07.1.07	Subnet mask	000.000.000.000	Set the correct Subnet mask
P07.1.08	IP port	1001	502
P07.1.13	IP gateway address	000.000.000.000	Set the correct IP gateway address

ETHERNET INTERFACE CONFIGURATION - JANITZA



The Ethernet Interface must be set and configured according with the network to which it is connected, please refer to the instructions below.

TCP/IP addressing quick guide

Manual TCP/IP settings

Switch to the programming mode:

- Press button 1 and 2 simultaneously for around 1 second to switch to the programming mode. The symbols for the programming mode PRG and the current transformer mode CT appear on the display.

Adjust the TCP/IP address (Adr.)

- Press button 2 to select "Adr"
- Press button 1 to enable the first digit (byte 0) of the address (digit is flashing), press button 2 to set the digit.
- Press button 1 to select the next digit (flashing) and set the desired digit by pressing button 2.
- If byte is set to 0, the address can be set from 1 to 3 by pressing button 1. Then the display jumps back to Byte 0 (no digit is flashing).

Subnet mask (SUB)

- Press button 2 to select the subnet mask and set it in a manner similar to adjusting the address by pressing button 1 and 2.

Adjusting the gateway address (GAt)

- Use button 2 and 1 to set the gateway in a manner similar to adjusting the address.

Deactivate dynamic IP allocation (cf. page 41)

- Set the parameter "dYn IP" to the "Fixed IP address" mode

Exit programming mode

- Press button 1 and 2 simultaneously to exit the mode or wait 60 seconds.

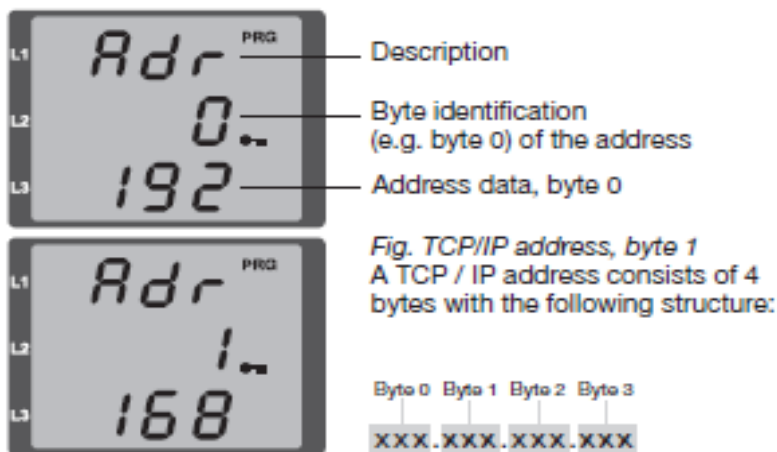

Activate/deactivate dynamic IP allocation (dyn)

Device/gateway address and subnet mask are assigned by a DHCP server and enable automatic integration of the device into the existing mains.

- When in programming mode, press button 2 repeatedly to display the tab labelled "dYn IP" and activate the parameter with button 1.
- Select the parameter digit with button 1 and set the value (e.g. 000 = fixed IP address, 002 = Activated DHCP mode) with button 2.

Exit programming mode.

PEAK SHAVING CONFIGURATION

Modify a device 2019-03-25 10:58:33

Device Type: Peak shaving f()

Port:

IP Address:

Parameter Info
P1: Max Power of Plant:
[10;65000] KW

Parameters

P1:	<input type="text" value="10"/>	P17:	<input type="text" value="0"/>
P2:	<input type="text" value="0"/>	P18:	<input type="text" value="0"/>
P3:	<input type="text" value="500"/>	P19:	<input type="text" value="0"/>
P4:	<input type="text" value="2"/>	P20:	<input type="text" value="0"/>
P5:	<input type="text" value="0"/>	P21:	<input type="text" value="0"/>
P6:	<input type="text" value="0"/>	P22:	<input type="text" value="0"/>
P7:	<input type="text" value="0"/>	P23:	<input type="text" value="0"/>
P8:	<input type="text" value="0"/>	P24:	<input type="text" value="0"/>
P9:	<input type="text" value="0"/>	P25:	<input type="text" value="0"/>
P10:	<input type="text" value="0"/>	P26:	<input type="text" value="0"/>
P11:	<input type="text" value="0"/>	P27:	<input type="text" value="0"/>
P12:	<input type="text" value="0"/>	P28:	<input type="text" value="0"/>
P13:	<input type="text" value="0"/>	P29:	<input type="text" value="0"/>
P14:	<input type="text" value="0"/>	P30:	<input type="text" value="0"/>
P15:	<input type="text" value="0"/>	P31:	<input type="text" value="0"/>
P16:	<input type="text" value="0"/>	P32:	<input type="text" value="0"/>

On this (virtual) device the parameters that can be changed are:

- P1: Max Grid Power: (0; 65000) kW (Max power that can be absorbed by the grid)
- P2: Back Energy: 0=not active 1=active (Back Energy to the grid)
- P3: Integral constant of regulator: 0=0.000 → 999=0.999 (reserved for service, standard 500)
- P4: Regulator's time constant: (1; 30) seconds (reserved for service, standard 2)

POWER METER CONFIGURATION

The setting necessary for the configuration of the Power Meter devices are the Port, IP address and Device Brand, as seen in the following image.

Modify a device 2020-04-27 12:02:05

Device Type: Power Meter

Port:

IP Address:

Device brand:

Parameter Info

Parameters

P1:	<input type="text" value="8"/>	P17:	<input type="text" value="0"/>
P2:	<input type="text" value="44"/>	P18:	<input type="text" value="0"/>
P3:	<input type="text" value="1"/>	P19:	<input type="text" value="0"/>
P4:	<input type="text" value="0"/>	P20:	<input type="text" value="0"/>
P5:	<input type="text" value="0"/>	P21:	<input type="text" value="0"/>
P6:	<input type="text" value="0"/>	P22:	<input type="text" value="0"/>
P7:	<input type="text" value="0"/>	P23:	<input type="text" value="0"/>
P8:	<input type="text" value="0"/>	P24:	<input type="text" value="0"/>
P9:	<input type="text" value="0"/>	P25:	<input type="text" value="0"/>
P10:	<input type="text" value="0"/>	P26:	<input type="text" value="0"/>
P11:	<input type="text" value="0"/>	P27:	<input type="text" value="0"/>
P12:	<input type="text" value="0"/>	P28:	<input type="text" value="0"/>
P13:	<input type="text" value="0"/>	P29:	<input type="text" value="0"/>
P14:	<input type="text" value="0"/>	P30:	<input type="text" value="0"/>
P15:	<input type="text" value="0"/>	P31:	<input type="text" value="0"/>
P16:	<input type="text" value="0"/>	P32:	<input type="text" value="0"/>

MODBUS/TCP SERVER FUNCTION

The Modbus/TCP server is a component that allows an external Modbus/TCP client to give commands to the UPS. This is the typical scenario of an external EMS (Energy Manager Systems) sending commands to the UPS to obtain specific services.

The minimum polling time is 0,5 seconds.

The Modbus address mapping of this server is the following:

Modbus Address	Description	Note
1000	Command code register	The command, this is an integer number different from zero
1001	Command action register	1=ON, 2=OFF, 3=START, 4=EXTRA
1002	Parameter 1	Command parameters
1003	Parameter 2	
1004	Parameter 3	
1005	Parameter 4 Time-out (s)	
...		
2000	Command result	1=OK, 2=KO
2001	Number of OK messages	
2002	Number of KO/bad messages	

Parameter 4 – Time-out

The Time-out parameter indicates the validity time of the given command, if this parameter is 0 (zero) it is considered with an unlimited duration.

With a parameter other than zero, and willing to keep the command active, it is necessary to refresh the command before the Time-Out expires.

This procedure ensures that a command is no longer executed in case of communication lost between the TCP Server e.g. EMS) and the UPS.

- The register from address 1000 to 1005 must be written with a multiple write register message (function code: 0x10).

- To read registers from 2000 to 2002, use a *Read Holding Register* message (function code 0x03).

In the table on the following page the list of supported commands:

Command	Command code register value	Description
CMD_RADD_LIMIT_PERC	1	<p>This command sets a percentage limit for the current absorbed by the rectifier.</p> <p>To activate, set register: <u>- 1000 at 1</u> - 1001 at 1 (1=ON) - 1002 at the value of percentage desired of maximum Rect.Curr. - 1003 Not Used - 1004 Not Used - 1005 Timeout (s)</p> <p>As stated before, use a <i>write multiple registers</i> to write the values.</p> <p>To disable the percentage limit, prepare the registers as above, but with register 1001 set to the value 2 (2=OFF), and perform a new <i>write multiple register</i>.</p>
CMD_INV_VOUT_NOM	2	<p>This command sets the nominal output voltage of the UPS.</p> <p>To activate, set register: <u>- 1000 at 2</u> - 1001 at 3 (3=START) - 1002 at the value of voltage desired, (range 60; 315) - 1003 Not Used - 1004 Not Used - 1005 Not Used</p> <p>The real range of accepted voltage is limited by UPS.</p>
CMD_PBATT_PERC_VAL	3	<p>This command sets the percentage of battery power to be taken or give to the battery:</p> <ul style="list-style-type: none"> - positive value means discharge batteries - negative value means charge batteries <p>To activate, set register: <u>- 1000 at 3</u> - 1001 at 1 (1=ON) - 1002 at the value of percentage related to nominal UPS power - 1003 Not Used - 1004 Not Used - 1005 Timeout (s)</p> <p>As stated before, use a write multiple registers to write the values.</p> <p>To disable the percentage limit, prepare the registers as above, but with register 1001 set to the value 2 (2=OFF), and perform a new write multiple register.</p> <p><u>- Available only for MHT/MHE and HBS HE series.</u></p> <p>Setting the register 1001 to 4 (EXTRA command), the Modbus client can set at register 1002 the value of percentage to apply in case the Energy Manager board detects loses communication with the source of commands (Modbus client itself). This value is <u>not persistent</u>, so the client must set the value when communication is restored in any case.</p>

Command	Command code register value	Description
CMD_Q_PERC_VAL	4	<p>This command sets the percentage of reactive power exchanged with the grid by rectifier:</p> <ul style="list-style-type: none"> - positive value means reactive power generation - negative value means reactive power absorption <p>To activate, set register:</p> <ul style="list-style-type: none"> - 1000 at 4 - 1001 at 1 (1=ON) - 1002 at the value of percentage related to nominal UPS power - 1003 Not Used - 1004 Not Used - 1005 Timeout (s) <p>As stated before, use a write multiple registers to write the values. To disable the percentage limit, prepare the registers as above, but with register 1001 set to the value 2 (2=OFF), and perform a new write multiple register.</p> <p><i>- Available only for MHT/MHE/NXE and HBS HE series.</i></p>
CMD_RESET_COMMANDS	0x8000	<p>To reset all the previous commands, send this command, setting register 1000 to 0x8000, and 1001 to 3. As usual, perform a <i>write multiple registers</i> to write the values.</p>

MASTER/SLAVE FUNCTION

In case of UPS in parallel configuration, it is necessary to insert an EnergyManager board in each unit of the group. It is also very important to grant that all the EnergyManager boards must be connected at the same Ethernet Network.

The multiple EnergyManager boards configuration works using a Master/Slave philosophy and is necessary in the following system configurations:

- UPS system in parallel configuration with common battery. In this case, only one EnergyManager board is responsible for querying the BMS and for propagating the information to the other boards in the group.
- Parallel UPS system configuration with dynamic Peak Shaving function activated. In this case, a single EnergyManager board interrogates the external Power Meter and sends the control signals to all the UPS in the group in a coordinated way.

Note: in case of UPS system in parallel configuration but with separated lithium battery, each UPS has to be equipped with an Energy manager board, but they run all independently (no set Master/Slave function).

Note: MODBUS commands sent to the TCP server are always and only addressed to the single UPS and are not propagated by the Master/Slave function.

In order to activate the Master/Slave function, the EnergyManager board must be configured using the "EnergyManager Configurator" software; the only parameter to be provided is the "group ID" which must be the same for all the boards of the parallel system.

In the following example, the Group ID has been set equal to 1.

Any other UPS, not part of the parallel group systems, connected to the same ethernet network must have different Group IDs.

Configuration management

Battery Management

- BMS component
- Rwe configuration
- BMS Yuasa
- BMS Cegasa
- BMS ADSTec
- RTU Rwe
- BMS Hoppeke
- BMS Streetscooter
- BMS Vision
- BMS Soltaro

Special functions and services

- Peak Shaving
- Modbus/TCP server
- Master/Slave

Peak shaving

- Peak shaving f() active
- Power meter - 1
- Power meter - 2
- Power meter - 3
- Power meter - 4

Modify a device 2020-11-12 14:32:23

Device Type: Master/Slave f()

Group ID: 1

IP Address: N.A.

Parameter Info

P1:	0	P17:	0
P2:	0	P18:	0
P3:	0	P19:	0
P4:	0	P20:	0
P5:	0	P21:	0
P6:	0	P22:	0
P7:	0	P23:	0
P8:	0	P24:	0
P9:	0	P25:	0
P10:	0	P26:	0
P11:	0	P27:	0
P12:	0	P28:	0
P13:	0	P29:	0
P14:	0	P30:	0
P15:	0	P31:	0
P16:	0	P32:	0

CONFIGURATION EXAMPLE FOR A COMMON BATTERY SYSTEM:

After activation of the Master/Slave function on all the boards, it is possible to configure the necessary functions on one of the boards and propagate the configuration to the other boards of the same group.

- 1) Configure all the boards by entering the Master/Slave function with the same Group ID.

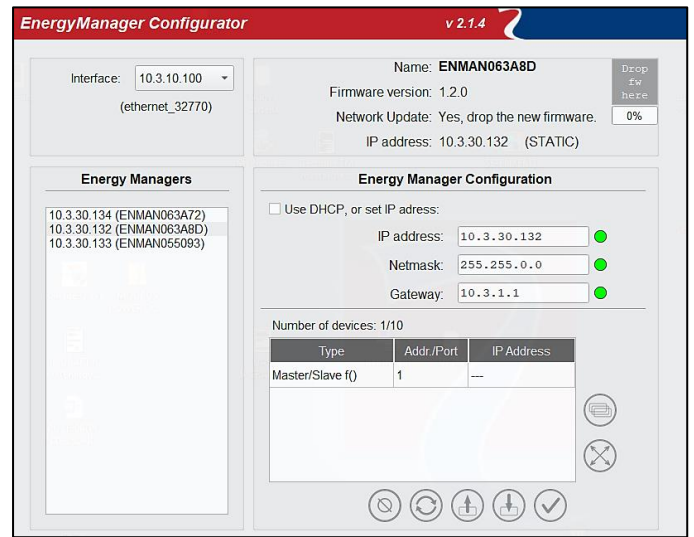
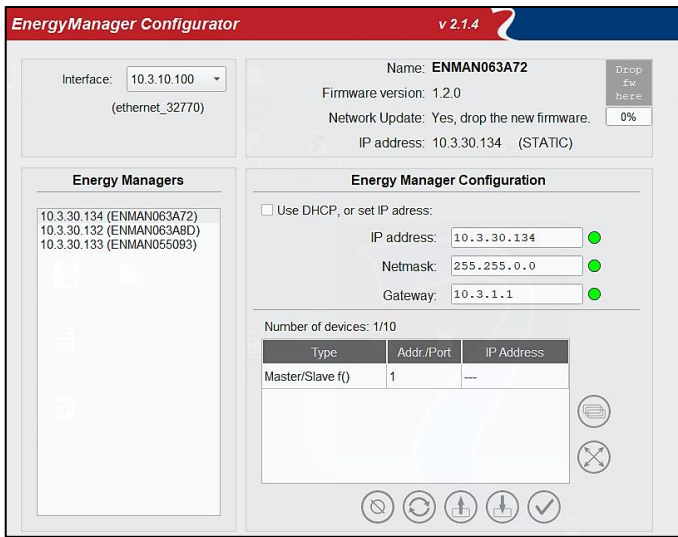

- 2) Configure a board with the BMS function and save it. It is essential to save the configuration before it can be propagated to other boards.

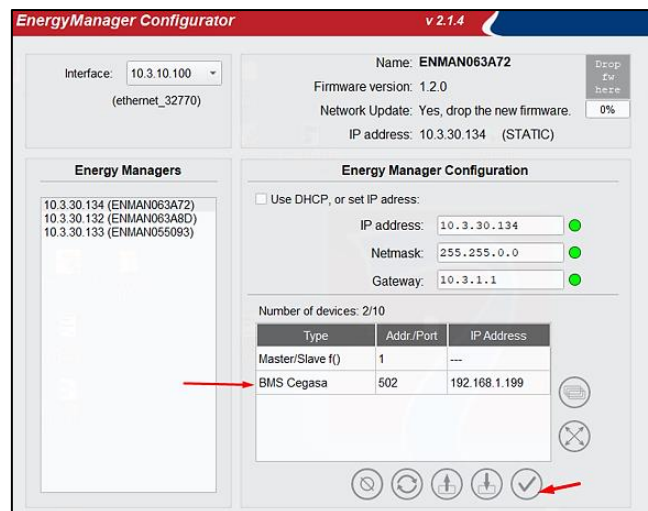

- 3) Propagate the configuration to the other boards.

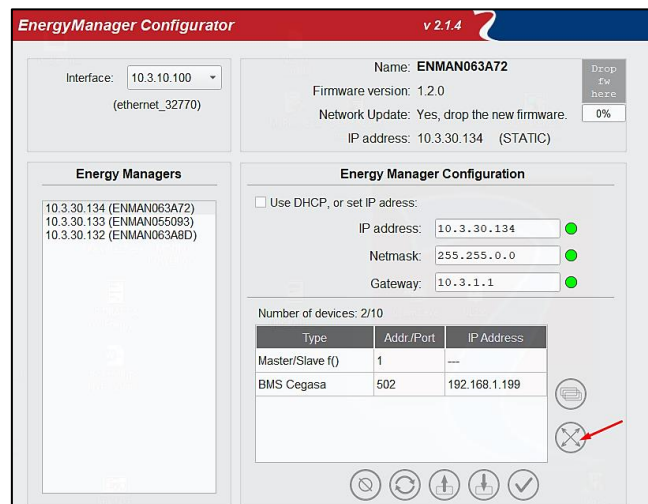

- 4) At this point all the boards of the group have inherited the same configuration.

COMMUNICATION DIAGRAM WITH SERIAL BMS AND POWER METER

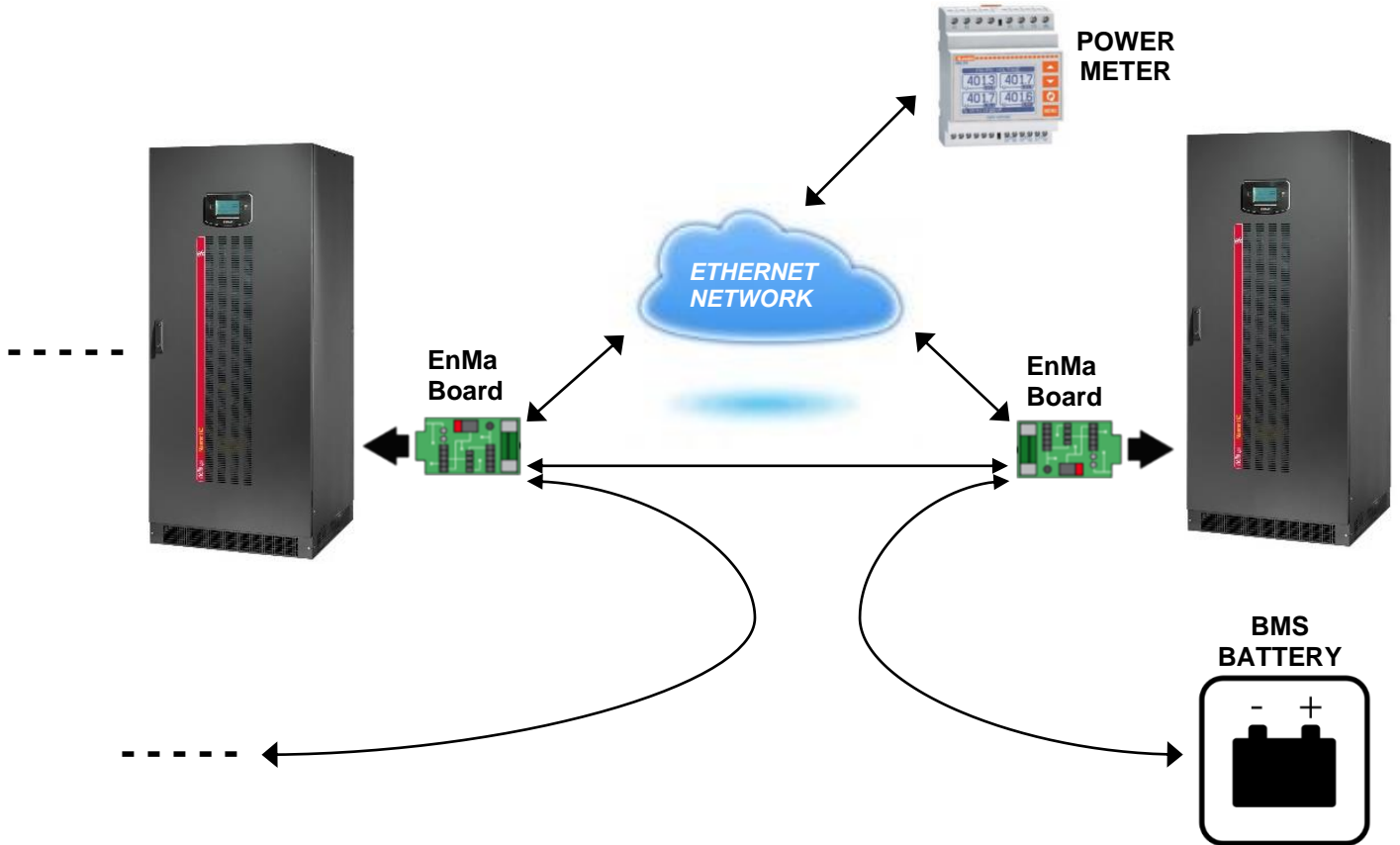

COMMUNICATION DIAGRAM WITH ETHERNET BMS AND POWER METER

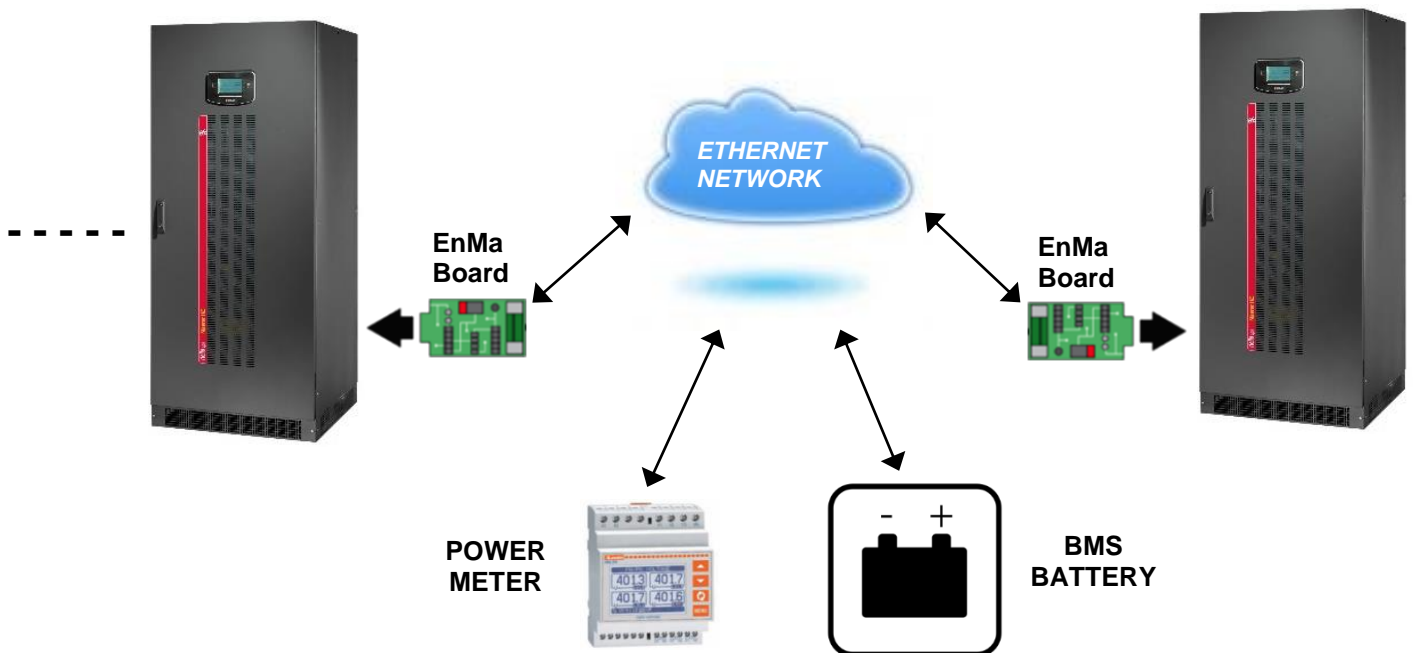

ENERGYMANAGER MONITORING

Using a VNC client (a free downloadable software from the internet) is it possible to:

- monitor the EnergyManager board,
- verify the configuration set of the board
- check the operating status.

To connect the VNC client to the EnergyManager board is necessary to enter the IP address of the board and the password which is "secret".

The VNC port is the default one: 5900.

The following images show samples of this virtual display:

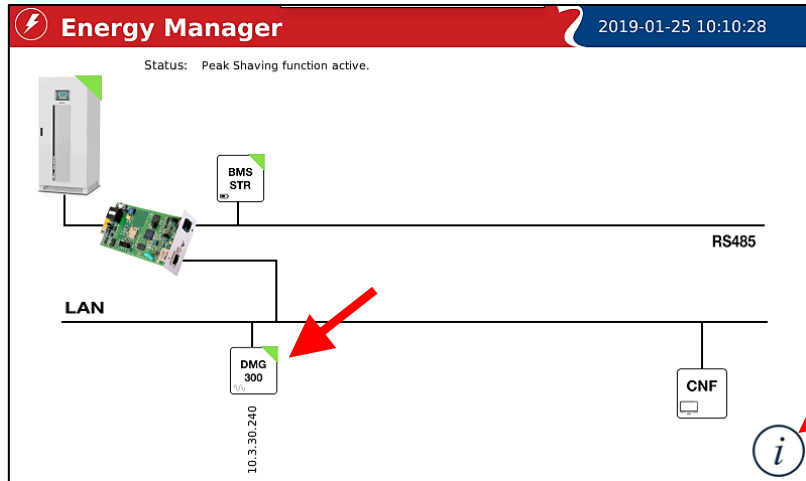

Pressing on the Information System icon



it's possible to see the detail of the software version of the EnergyManager card.

Firmware version:	1.1.0
MCU Version:	e3300003AAA
Build date:	Mar 21 2019
Kernel:	3.12.1-EK20190222
Cpu:	ARM926EJ-Srev5(v5l)
Hostname:	ENMAN0580C2
IP Address:	10.3.30.232 (255.255.0.0) DHCP: no
Uptime:	11:47:35 up 5 days, 18:55, 1 user, load average: 0.14, 0.42, 0.46
Last Fatal:	

Pressing on the configured components, it's possible to see, when possible, the detail of the component.

FIRMWARE UPGRADE

EnergyManager can be upgraded via HTTP using the web browser interface.



EnergyManager is provided by default with the DHCP enabled



EnergyManager requires approximately 2 minutes to become fully operational from when it is powered up or following a reboot; before this time the device may not respond to commands that are sent to it



The firmware Application component comes with 2 files and both files are needed for upgrade: - **IMAGE** file (.app208) - **JSON** file (.json)



Uploading image files involves the reading and the transmission of huge data, therefore is strongly suggested to not loading the image file from the network / local network but to copy locally the image files on the computer

- 1- To upgrade the firmware, you must reboot the EnergyManager to enter the **Recovery Mode**.
- **Recovery mode:** using the EnergyManager Configuration software, select the EnergyManager card to update and press the button at the top right with the word **UPDATE**. The led of the EnergyManager starts blinking green.

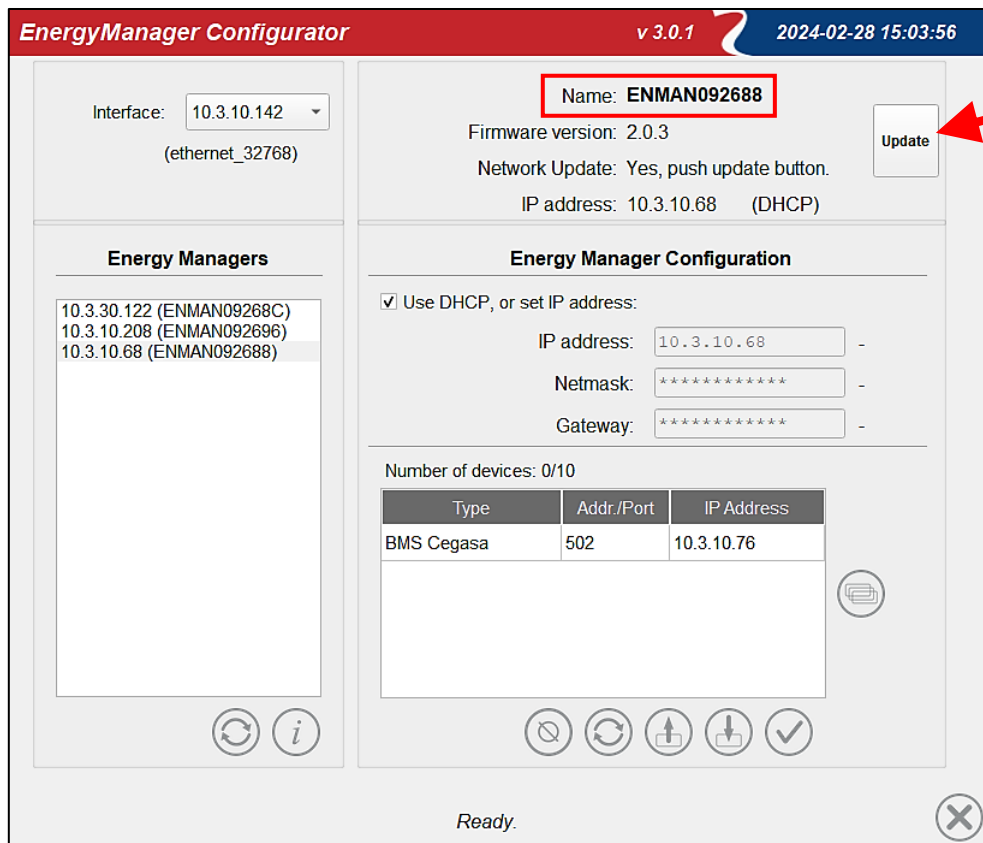

2- The following warning appears on the video

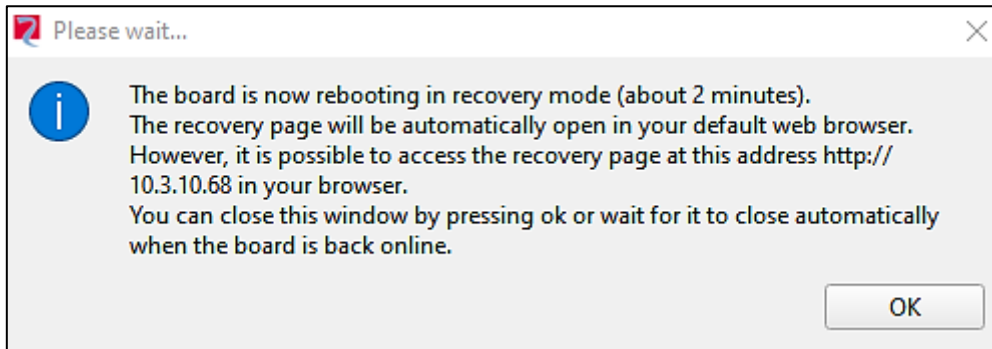

3- After about two minutes a browser page is automatically opened with the "**IP address**" assigned to the EnergyManager and you will access the following screen

 Other way, if you open the browser but cannot reach the EnergyManager with the assigned IP address, type the following address: **http://enmanXXYYZZ.local** where instead of the letters XXYYZZ insert the numbers present in the name of the EnergyManager (in this case **092688**).

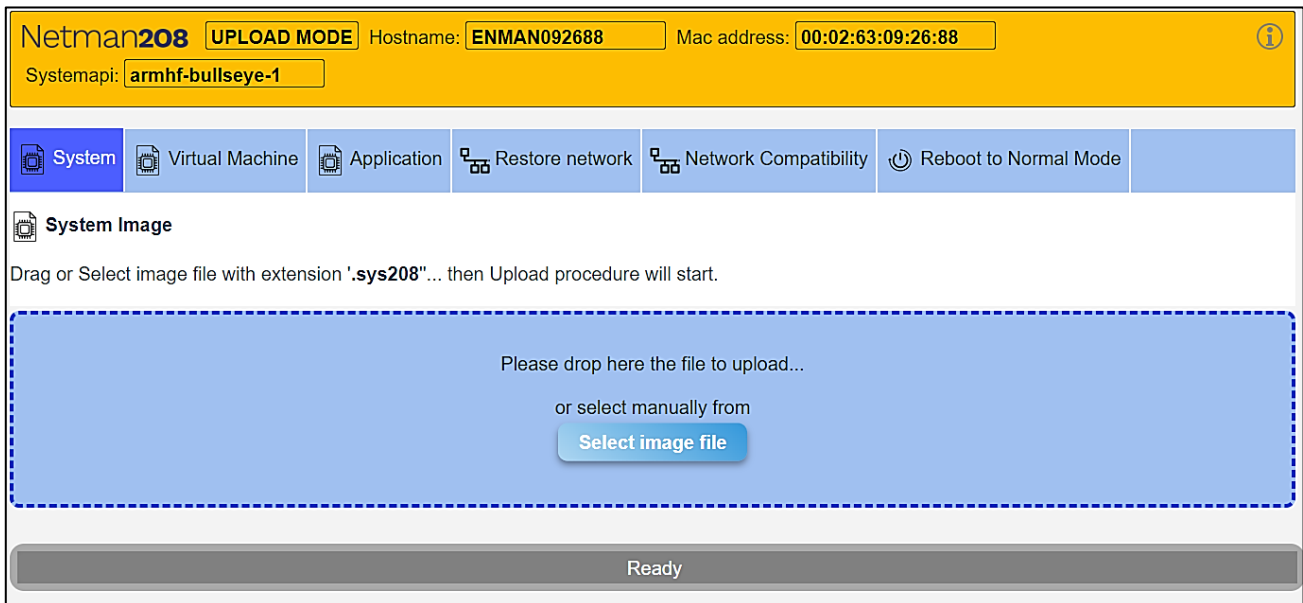

4- From the menu select **Application**

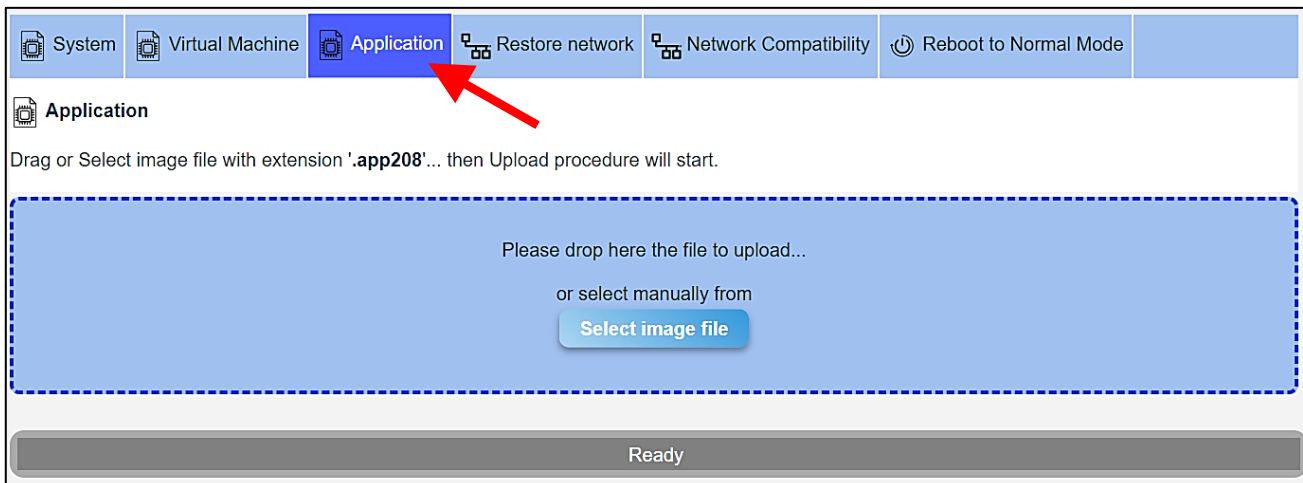

5- Select the image file “.app208” or drag and drop the file

6- Select the JSON file “.json” or drag and drop the file

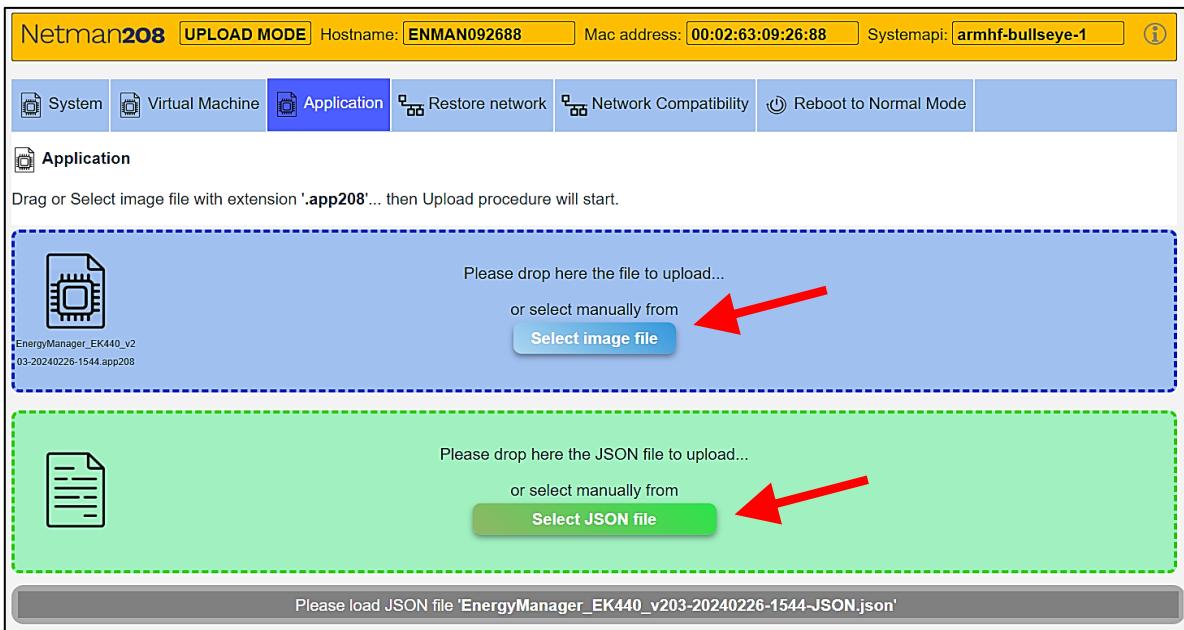

7- After upload the JSON file, in case of no error, the Web page proceeds to calculate the Checksum of the file

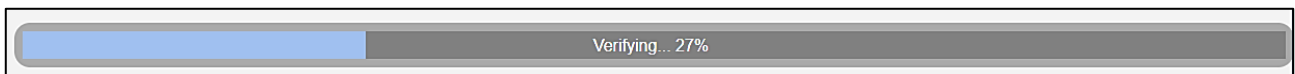
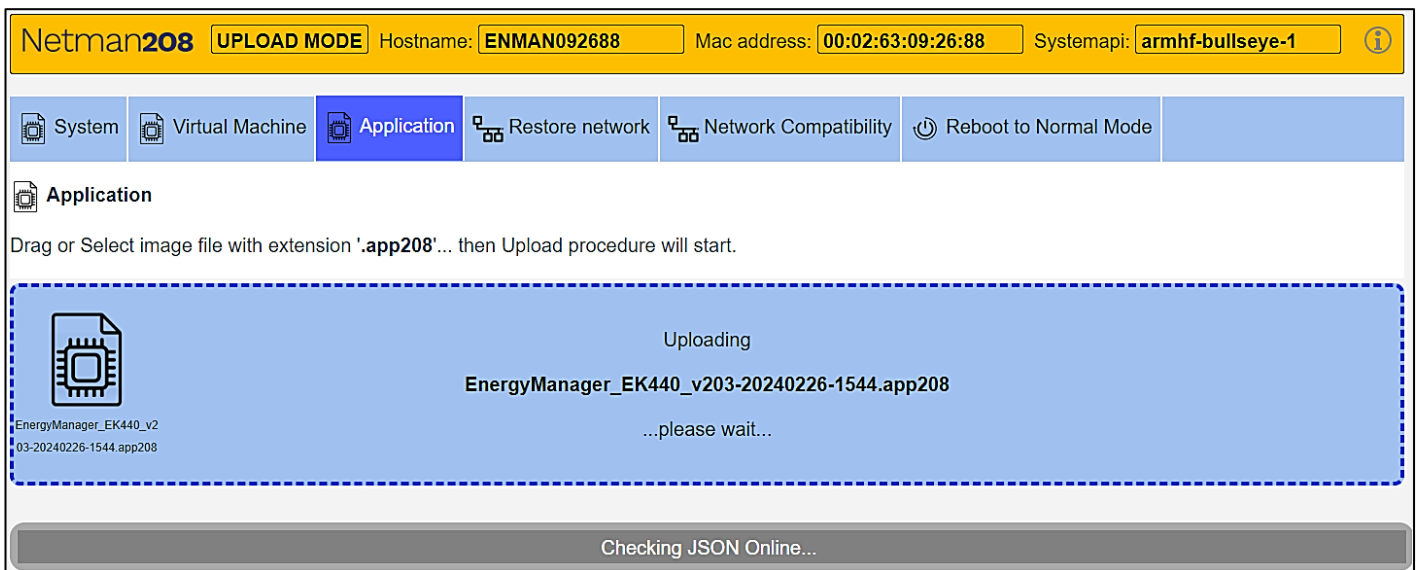

8- Checksum calculated is compared to the checksum loaded from JSON file: if it matches proceeds to upload the Image file overwriting existing image in the *EnergyManager*

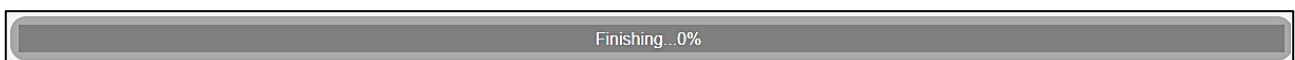
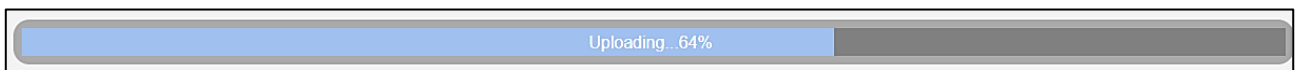

9- At the end, you must reboot the *EnergyManager* to Normal Mode

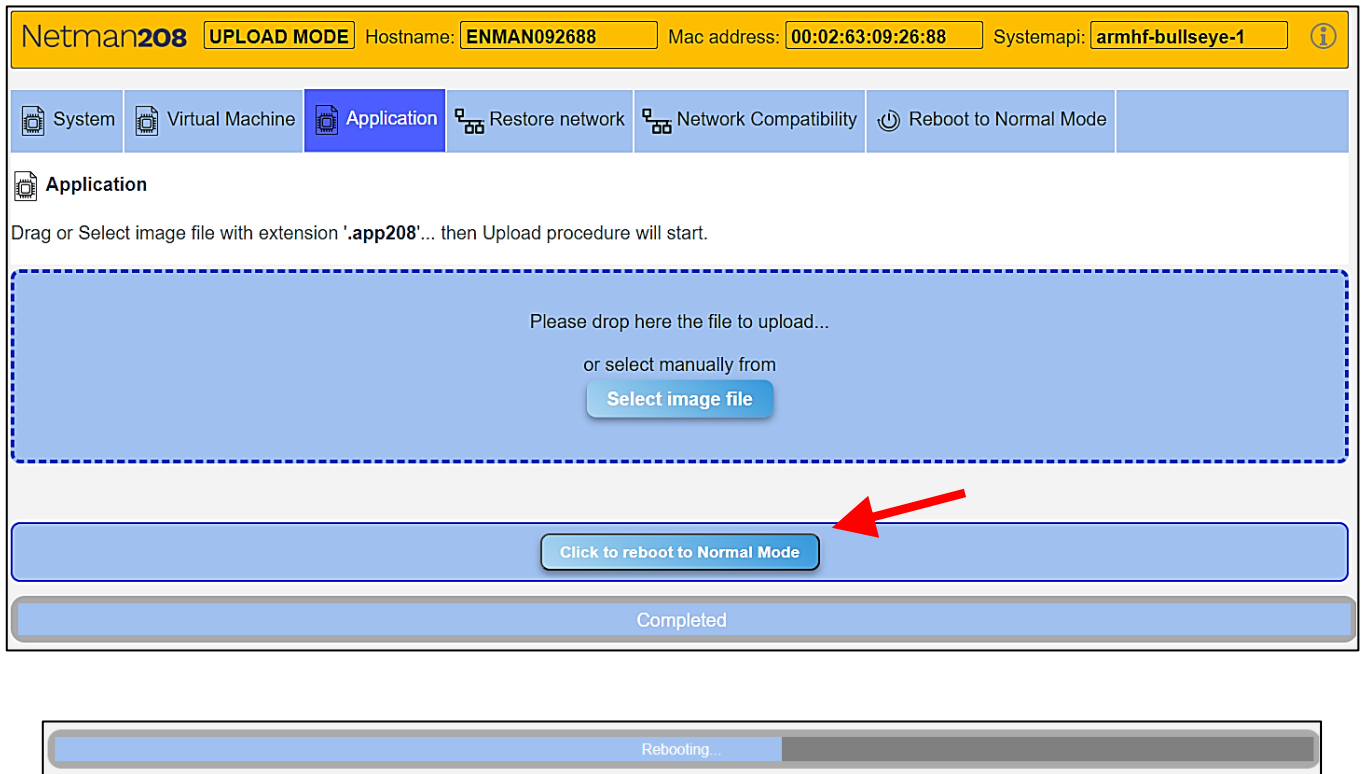

10- The *EnergyManager* returns to normal operation

UPS SETTING

CONFIGURATION FOR NEXTENERGY AND MASTER SERIES

No configuration is necessary for the UPS of the NextEnergy and Master series.

The battery voltage and current values communicated by the BMS act on the UPS charge regulation, if the UPS internal thresholds, set by the UPS display, are more restrictive, the latter will be applied. (See the UPS display manual)

CONFIGURATION FOR UPS SENTRYUM (S3T/S3M/S3U)

Configuration software: S3Config 3.0.3 or higher

UPS firmware revision: 01.16 or higher

The screenshot shows the S3 Configurator software interface. The 'Battery' tab is selected in the left sidebar. The main panel displays various configuration options for the battery. The following settings are highlighted with red boxes:

- Battery type:** Lithium + BMS
- Custom recharging voltage [V]:** 268,0
- Custom end discharge voltage [V]:** 190,0

Other visible settings include:

- Battery mode: Separated
- Battery low time [min]: 3
- Autonomy limitation [sec]: Disabled
- External battery temperature probe: Disabled
- External battery temperature alarm [°C]: 33
- Temperature alarm hysteresis [°C]: 3
- Internal CB maximum current [A]: 6,0

At the bottom of the interface, there are buttons for 'Disconnect', 'Advanced Service', and 'Default data'.

Battery type

Select the battery type "Lithium + BMS"

Custom recharging voltage

This parameter is used only if the BMS does not provide the charging voltage threshold. Normally it is not necessary to set this value.

(Range: 240V÷300V)

[Default: 268V]

Custom end discharge voltage

To set the extreme cut-off threshold for end of discharge.

The normal cut-off threshold for end of discharge is controlled directly by the BMS.

(Range: 190V÷230V)

[Default: 190V]

CONFIGURATION FOR UPS MULTI POWER (MPW/MPX)

Configuration software: MPWConfig 3.0.2 or higher

PM-mC firmware revision: 02.06 or higher

MCU firmware revision: 01.49 or higher

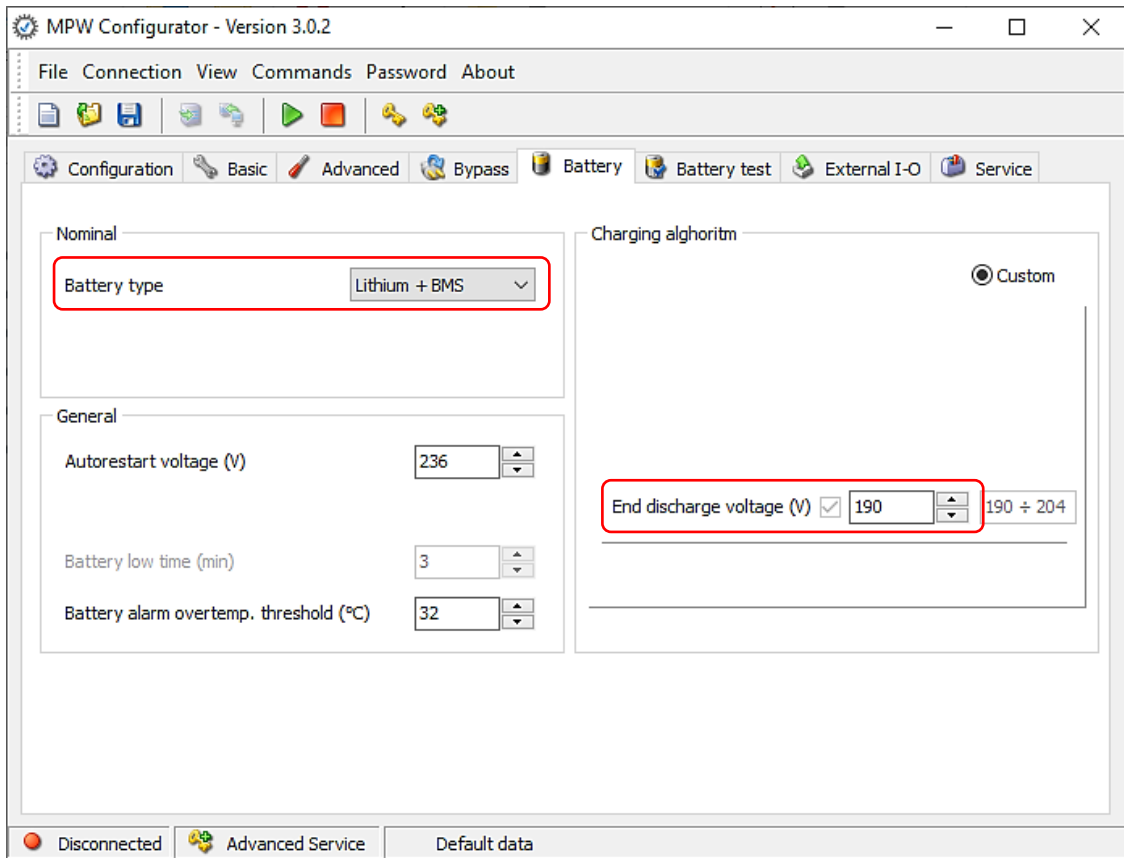

Battery type

Select the battery type "Lithium + BMS"

End discharge voltage

To set the extreme cut-off threshold for end of discharge.

The normal cut-off threshold for end of discharge is controlled directly by the BMS.

(Range: 190V÷230V)

[Default: 190V]

CONFIGURATION FOR UPS MULTI POWER2 (MP2/M2S)

Configuration software: MP2Config 1.0.0 or higher

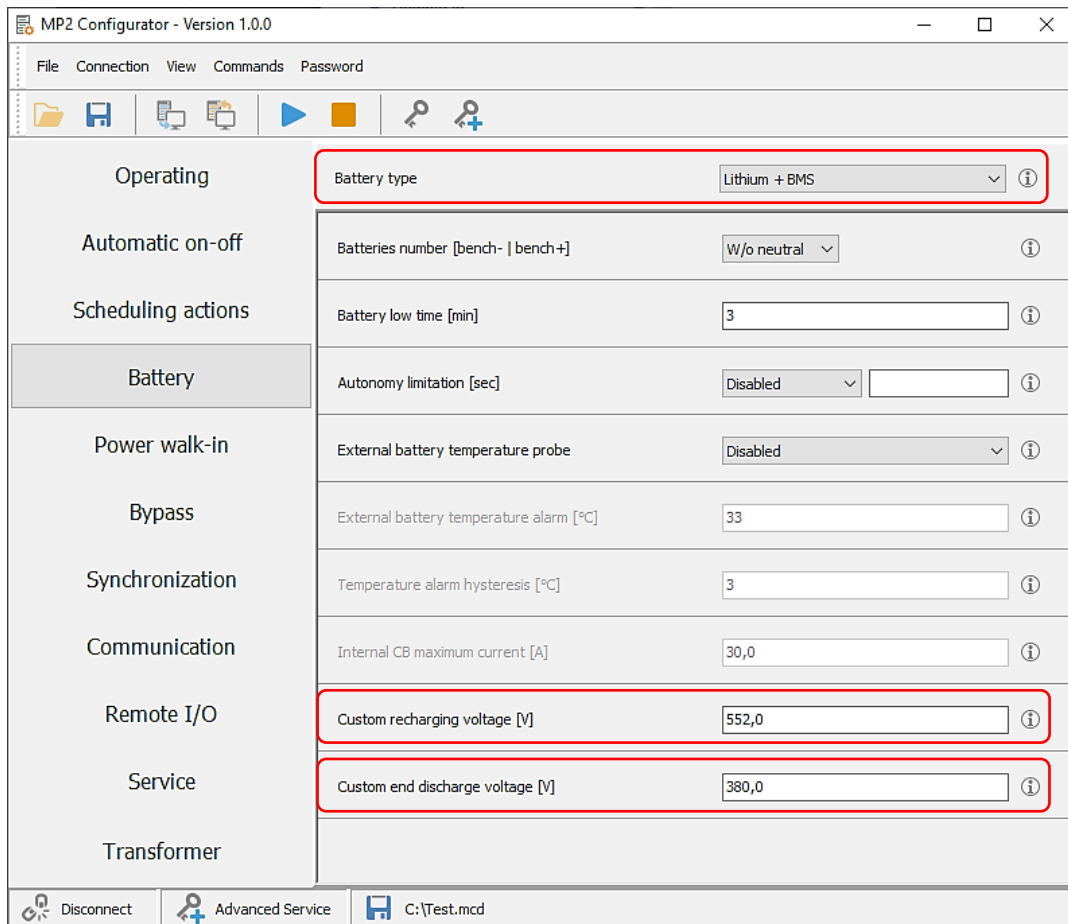

Battery type

Select the battery type "Lithium + BMS"

Custom recharging voltage

This parameter is used only if the BMS does not provide the charging voltage threshold. Normally it is not necessary to set this value.

(Range: 480V÷600V)

[Default: 552V]

Custom end discharge voltage

To set the extreme cut-off threshold for end of discharge. The normal cut-off threshold for end of discharge is controlled directly by the BMS.

(Range: 380V÷460V)

[Default: 380V]

ALARM MESSAGES

The alarm messages that may appear on the UPS/Storage display are as follows:

ALARM	CAUSE
EnMan LOST	The EnergyManager board has lost communication with the UPS/Storage
Meter LOST	The external power meter has lost communication with the EnergyManager board (peak shaving function)
BMS ALARM	The BMS is in an alarm or warning status
COMM.BMS = OFF	The EnergyManager board has lost communication with the BMS

NOTE:

The alarm messages are not displayed if the UPS/Storage is in "System OFF" status.



RPS SpA – Riello Power Solutions

Viale Europa, 7
37045 Legnago (VR)
Italy

www.riello-ups.com

02/2024

OMNACCENMENUMH